

OCTOBER 10, 2024

RNI - 11176/67

Volume - 58 Issue - 10

Price Rs. 50/-

RAJKOT ENGINEERING INFORMATION BULLETIN

Postal Regn. No. Rajkot/309/2024-2026

Valid Up to 31-12-2026 Office of Posting RMS-Rajkot.

Published & Posted on dtd., 10th Every Month

Visit Rajkot Engineering
Association Pavilion



18th - 21st JANUARY, 2025

YESHOBHMI - INDIA INTERNATIONAL CONVENTION
& EXPO CENTRE (IICC), DWARKAM NEW DELHI, INDIA

ACMA Mobility Foundation

**Bharat
Mobility**
GLOBAL EXPO 2025



RAJKOT
ENGINEERING
ASSOCIATION



SINCE 1963

www.reaindia.com

“पहेचान
“नये
“स्वाद की!

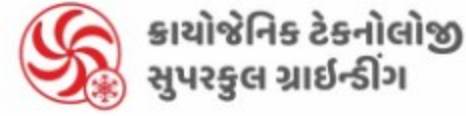

મસાલાને સુપરકુલ ટેમ્પરેચરમાં દળાય છે એટલે મસાલાના ગુણધર્મ સુરક્ષિત રહે છે

દેવપરા આઉટલેટ

કોઠારિયામેઈન રોડ, દેવપરા શાકમાર્કેટ સામે,
રાજકોટ, ગુજરાત - 360002
કોન્ટેક નંબર : +91 99099 20331

અમીનમાર્ગ આઉટલેટ

કે.સી.એલ બિલ્ડીંગ ગ્રાઉન્ડ ફ્લોર, સિટી
સ્કવેર માર્ટ ની સામે, અમીન માર્ગ, ૧૫૦
ફૂટ રિંગ રોડ નજીક, રાજકોટ - 360001
કોન્ટેક નંબર : +91 99099 20489

જુનાગઢ આઉટલેટ

માનસી કોમ્પ્લેક્સ, જનકપુરી,
અંબરડા રોડ, જુનાગઢ - 362001
કોન્ટેક નંબર : +91 99099 13779

Email: sales@farmkingfood.com | Web: www.farmkingfood.com



Farmking Food Products Pvt Ltd

UPLIFT YOUR CLASS WITH
KICH S. S. 316 GRADE PREMIUM QUALITY
ARCHITECTURAL PRODUCTS



Hardware Products



Glass Fittings



Furniture Fittings



Bathroom Fittings



Railing Systems



Digital Solutions

GLIMPSE OF FEW OF OUR PRESTIGIOUS PROJECTS...



CENTRAL VISTA - DELHI



SARDARDHAM BHAVAN
- AHMEDABAD



ATAL BRIDGE- AHMEDABAD



INTERNATIONAL AIRPORT - PUNE



RAM MANDIR - AYODHYA



All India Institute of Medical Sciences
(AIIMS) - RAJKOT



INTERNATIONAL AIRPORT - LUCKNOW



BAPS HINDU MANDIR ABU DABI - UAE

KICH ARCHITECTURAL PRODUCTS PVT. LTD.

Rajkot-Gondal NH-27, Vavdi, Rajkot-360004 (Guj.) INDIA. Helpline: 1800 212 3836 | www.kichindia.com



Discover
Comfort & Style



CLUB ROOM



SUPERIOR ROOM



EXECUTIVE ROOM

Get ready to experience comfort like never before. With plush bedding, state-of-the-art amenities, and intuitive design, your RPJ hotel room is your oasis in the heart of the city.

Our Facilities

- Swimming Pool
- 92 Rooms
- Gym
- Banquets
- 24*7 Coffee Shop
- Restaurants

+91 281 6167777

Everest Park, Kalawad Road, Rajkot - 360005

www.rpjhotelrajkot.com

reservation@rpjhotels.com

RPJ
HOTEL
KALAWAD ROAD, RAJKOT

RAJKOT ENGINEERING INFORMATION BULLETIN

Volume - 58

Issue - 10

OCTOBER - 2024

Price Rs. 50/-



RAJKOT ENGINEERING ASSOCIATION

President

Shri Narendra V. Panchani



Vice President

Shri Jignesh S. Adroja



Hon. Secretary

Shri Vinod K. Asodariya



Jt. Hon. Secretary

Shri Chandresh Patel



Hon. Treasurer

Shri Ashish D. Sardhara



Editor

Shri Jay Mavani

અનુક્રમણિકા

ક્રમ	શિર્ષક	પે.નં.
૧	તંત્રી સ્થાનેથી	૬
૨	ડીરેક્ટરી તથા બુલેટીનના જાહેરાતના દર	૨૯
૩	સંસ્થા સમાચાર	૩૦
૪	એક્ષ્પોટર્સ માટે સર્ટીફિકેટ ઓફ ઓરીજીન ચાર્જસ	૩૧
૫	કાર્ય સારાંશ	૩૨
૬	Auto Expo-2025 The Components Show ખાસ અંક	૩૬
૭	આર.ઈ.એ. ના સભ્યો તથા પરિવાર માટે આંખની સારવાર માટે એમ.ઓ.યુ. કરેલ	૩૭
૮	રાજકોટ એન્જી. એસોસીએશન ઓડીટોરીયમ હોલ વપરાશ ચાર્જસ	૪૦

મેગેઝિન રાજકોટ એન્જીનીયરીંગ ઇન્ફોર્મેશન બુલેટિન અજય પ્રિન્ટીંગ પ્રેસ, ૨-પટેલનગર, ૮૦ ફુટ રોડ, રાજકોટ-૪ ખાતે છપાયું તેમજ રાજકોટ એન્જીનીયરીંગ એસોસીએશન વતી રાજકોટ એન્જીનીયરીંગ એસોસીએશન, ભક્તિનગર ઇન્ડસ્ટ્રીયલ એસ્ટેટ ખાતેથી શ્રી જય વ્રજલાલ માવાણી દ્વારા મુદ્રિત અને પ્રકાશિત થયું. તંત્રી-શ્રી જય વ્રજલાલ માવાણી.

Magazine "Rajkot Engineering Information Bulletin" Printed and Published by Mr. Jay Vrajlal Mavani on behalf of Rajkot Engineering Association and Printed at Ajay Printing Press, 2-Patel Nagar, Off. 80 Feet Road, Rajkot-4. and published at Rajkot Engineering Association, Bhaktinagar Industrial Estate Rajkot. Editor-Mr. Jay Vrajlal Mavani

Magazine : Rajkot Engineering Information Bulletin
Volume : 58
Issue : 10
Continuous Issue : 694
Date : 10-10-2024
Page : 60

સામચિત્ર : રાજકોટ એન્જીનીયરીંગ ઇન્ફોર્મેશન બુલેટિન
વર્ષ : ૫૮
અંક : ૧૦
સર્ગ અંક : ૬૯૪
તારીખ : ૧૦-૧૦-૨૦૨૪
પાના : ૬૦



RAJKOT ENGINEERING ASSOCIATION

Bhaktinagar Industrial Estate, G.I.D.C., Street No.-3, Rajkot-360 002.

Ph. : +91-281-2362235 / 36, Mo. +91 99132 14935

E-mail : info@reaindia.com

Website : www.reaindia.com

Disclaimer : Statements, Opinions and Views given in the news articles and papers appearing in this Bulletin are the expressions of Contributors, for which the Editor and the Association assume no responsibility

તંત્રી સ્થાનેથી...

તા. ૦૧/૧૦/૨૦૨૪

“ભારતમાં i-phone મેન્યુફેક્ચરિંગનો નવો અઘ્યાય”

જોવાના દ્રષ્ટિકોણ માટે એક જુનો મહાવરો છે. પાણીનો ગ્લાસ અડધો ભરેલો હોઈ તેને Optimistic એટલે કે આશાવાદી માણસ અડધો તો ભરણ ગયો છે તેવી રીતે જોવે છે અને Pessimistic એટલે કે નિરાશાવાદી માણસ હજુ તો અડધો ખાલી છે. તેવી રીતે જોવે છે. ભારતમાં સ્માર્ટફોન મેન્યુફેક્ચરિંગ ભાખતે આવુ જ કંઈક છે. જે ગ્રેટ અથવા સાધન હવે દરેક વ્યક્તિના હાથમાં અનિવાર્યપણે જોવા મળે છે તે હજુ થોડા વર્ષો પહેલા સંપૂર્ણપણે ઈમ્પોર્ટ પર જ આધારિત હતું. જે ઝડપે મોબાઈલ ફોન ઈન્સ્ટ્રુમેન્ટનો ઉપયોગ વધતો હતો તે જોવા જો સંપૂર્ણ પહે તેના માટે ઈમ્પોર્ટ પર જ આધારિત રહીએ તો પેટ્રોલિયમ પછી તે વિદેશી ડુંડિયામણ ખાઈ જનારી બીજી સૌથી મોટી આઈટમ બની જાય. આના નિરાકરણ માટે માનનીય વડાપ્રધાનશ્રી નરેન્દ્રભાઈ મોદીએ પોતાની સીધી દેખરેખ હેઠળ નવી ઈલેક્ટ્રોનિક્સ PLI(પ્રોડક્શન લિંક ઈન્સેટિવ) સ્કીમ અમલમાં મુકી જેના અંતર્ગત મોબાઈલ મેન્યુફેક્ચરરોને અમુક વિશેષ આર્થિક સવલતો આપવાની જોગવાઈ કરવામાં આવી. આને લઈને વિવિધ મોબાઈલ ફોન મેન્યુફેક્ચરિંગ કંપનીઓ જેવી કે Apple, Sumsung, MI, VIVO વગેરે એ સ્માર્ટફોન મેન્યુફેક્ચરિંગ ની અમુક અંતિમ પ્રક્રિયાઓ ભારતમાં શરૂ કરી.

તાજેતરમાં લોન્ચ થયેલ i-phone 16 એ એક નવો સિમાચિહ્ન સ્વપાઓ અને મોબાઈલ ફોન મેન્યુફેક્ચરિંગના મામલે કમસે કમ ગ્લાસ અડધો ભરેલો તો કહી શકાય તેવી પરિસ્થિતી ઉભી કરી દીધી. મેઈક ઈન ઈન્ડિયા ગુમેશમાં આ એક મોટી ઉપલબ્ધિ છે. એકતો એ કે કોઈ ગ્લોબલ ફોન મેન્યુફેક્ચરરે પહેલીવાર તેનો લેટેસ્ટ ફોન ભારતમાં મેન્યુફેક્ચર થયો હોઈ તેને વર્લ્ડ લેવેલે લોન્ચ કર્યો. બીજું એ કે આ ઘટનાએ એવું પ્રસ્થાપિત કર્યું કે સપ્લાઈ ચેઈનને ચાઈના બહાર પણ સફળતાપૂર્વક પ્રસ્થાપિત કરી શકાય છે અને એનો યશ ભારતનો ગયો. ત્રીજું એ કે જે ઈલેક્ટ્રોનિક્સ PLI સ્કીમ અમલમાં મુકવામાં આવી તે પરિણામ આપી રહી છે. ચોથું એ કે i-phone 16 જે પ્લાન્ટમાં મેન્યુફેક્ચર થાય છે ત્યાં મેજોરીટી સ્ત્રી કામદારોને રોકવામાં આવી છે જે સ્ત્રી સશક્તિકરણની દિશામાં મોટું પગલું છે.

Apple એક ગંજાવર અને પ્રોડીટ મેઈકિંગ કંપની છે. તેણે એપ્રિલ થી જુન-૨૦૨૪ ના ક્વાટરમાં અઘધ કહી શકાય તેવો રૂા. ૧.૭૫ લાખ કરોડથી વધુ નફો નોંધાવ્યો હતો જે ગયા વર્ષની સરખામણીએ ૭.૮% વધુ હતો. તેની પ્રિમિયમ ગ્રાન્ડ તરીકેની ગ્રાન્ડ વેલ્યુ હજુ પણ સંપૂર્ણપણે અકબંધ છે અને તેથીજ ઉચ્ચ ભાવે પોતાના હેન્ડસેટ વહોંચી તે આટલો જંગી નફો રળી શકે છે. આવી અતિ પ્રતિષ્ઠિત કંપની જો પોતાના લેટેસ્ટ મોડેલનું લોન્ચિંગ ભારતમાં સ્થિત ફેક્ટરી મારફતે કરે તો તે ચોક્કસ પણે આપણા માટે ગૌરવનો વિષય કહેવાય. Apple ના સૌથી મોટા સપ્લાયર Foxconn કંપની ના ચેરમેન Young Liu ને આ વર્ષે પદ્મભુષણ થી સન્માનિત કરી ભારત દેશે તેમના માટે ભારતનો ઉચ્ચતમ સન્માન અને અહોભાવ વ્યક્ત કર્યો છે.

પરંતુ ગ્લાસ હજુ અડધો ખાલી પણ છે. હાલમાં જે મોબાઈલ ફોનનું મેન્યુફેક્ચરિંગ ભારતમાં થાય છે તેમાં માઈક્રોએસેમ્બલીંગ અને લો કોસ્ટ પ્રોડક્ટ્સ જ મેન્યુફેક્ચરિંગ સામેલ છે. તેની અમુક કિંમતી સબ એસેમ્બલીઓ હજુ પણ ઈમ્પોર્ટ કરવી પડે છે અને અમુક સાદા અને સરળ કમ્પોનન્ટનું મેન્યુફેક્ચરિંગ જ ભારતમાં થાય છે. પરંતુ આ અડધા ગ્લાસને ભરવાની પ્રક્રિયા પણ સચનપણે સરકાર પ્રસ્થાપિત કરી રહી છે. ભારતમાં તાજેતરમાં સ્થાપવામાં આવેલ ઈલેક્ટ્રોનિક્સ વિપના પ્લાન્ટ આ દિશામાં એક મોટું પગલું છે. આ વિષયનું મેન્યુફેક્ચરિંગ સ્ટેબીલાઈઝ થઈ ૨૦૫ તો આ

જયભાઈ માવાણી

Cell : 98242 13751

E-mail : sales@turnmax.in



:: પ્રમુખશ્રી નો સંદેશ ::

ભારતના એન્જનીયરીંગ ઉત્પાદનમાં રાજકોટ - ગુજરાતની ભુમિકા અક્ષેસર રહી :

એન્જનીયરીંગ શહેર તરીકે જાણીતું ગુજરાતનું શહેર રાજકોટ એન્જનીયરીંગ ક્ષેત્રે હરણાકાળ ભરી રહ્યું છે અને વિશ્વના બીજા દેશોને દરેક રીતે હંફાવી રહ્યું છે. આ ક્ષેત્રમાં દરેક પ્રોડક્ટ્સ આજની તારીખે રાજકોટ ઉત્પાદન કરી રહેલ છે.

એન્જનીયરીંગ ક્ષેત્રમાં ખાસ કરીને ઓટોમોબાઈલ, મશીન ટુલ્સ, ફાઉન્ડ્રી, ફોર્જિંગ, ડિઝલ ઓઈલ એન્જીન, સબમર્સિબલ પમ્પ, ફુટ પ્રોસેસિંગ મશીનરી, ટેક્સટાઈલ, ડીફેન્સ, રેલ્વે તેમજ ચંદ્રચાન જેવા પ્રોડક્ટ્સના ઉત્પાદનમાં રાજકોટની ભુમિકા અક્ષેસર રહેલ છે. જે આપનારા ભવિષ્યમાં દેશનું નામ અગ્રણી હરોળમાં રાખી શકશે. સરકારી ટેકનોલોજીના વિકાસ માટેની જુદી જુદી સહાયથી આ ક્ષેત્રમાં ટેકનોલોજી ક્ષેત્રે રાજકોટનો વિશ્વ કક્ષાએ વિકાસ થયો છે. આપનારા સમયમાં ટ્રેડ ડેવલપમેન્ટ માટે પણ સરકાર આગળ આવશે એવી આશા રાખું છું. ટ્રેડ માટે સરકાર આજે પણ ઉદ્યોગોને મદદરૂપ થાય જ છે. આવી જ એક સહાયને અનુલક્ષીને રાજકોટ એન્જનીયરીંગ એસોસીએશન દ્વારા ૨૦ એમ.એસ.એમ.ઈ. એકમો સાઉથ કોરીયાના એક્ઝીબીશનમાં ભાગ લેવા તા. ૧૬ થી ૧૮ ઓક્ટો., ૨૦૨૪ દરમિયાન જય રહેલ છે. આ જલાવતા ખુશી થાય છે કે અમે આ ડેલીગેશનથી દેશનું પ્રતિનિધીત્વ કરવા જઈ રહ્યા છીએ કેમકે આ કોરીયા મેટલ વીક નામના એક્ઝીબીશનમાં “ઈન્ડિયા પેવેલીયન” તરીકે રાજકોટ એન્જનીયરીંગ એસોસીએશન જશે. કોરીયાના ઉત્પાદકો પાસેથી આ ઉદ્યોગકારો કઈ નવી ટેકનોલોજી શીખશે તેમજ ભારતમાં થતું ઉત્પાદન પણ કોરીયામાં સપ્લાય કરી શકે અને આમ વિકાસના દ્વાર ખોલશે.

આ સાથે બધા ઉદ્યોગકારો જે આ ડેલીગેશનમાં છે તેમણે અભિનંદન સહ શુભેચ્છા પાઠવું છું કે પોતાના માટે અને બીજા ઉદ્યોગો માટે નવા વેપારની ઉજળી તકો આપ બધા મેળવી શકો. આપ બધા પણ રાજકોટ અને દેશના વિકાસમાં સહભાગી થાઓ એવી શુભકામના.

નરેન્દ્ર પાંચાણી

પ્રમુખ



AATOMIZE®

NEVER COMPROMISE

BUSINESS OPPORTUNITY

FULLY STONELESS UPTO 10,000 KG FLOUR PLANT



MASALA PULVERIZER

3HP TO 30HP



1
NUMBER ONE in Grinding Solution

- Domestic Flourmill
- 2 in 1 Auto Pulverizer
- Masala Machine
- Sugar Grinding Machine
- Rice Mill Machine
- Dal Machine
- All Types of Food Processing Machinery

AATOMIZE MANUFACTURING PVT. LTD.

Shapar (Veraval), Rajkot-360024, Gujarat (INDIA).

www.aatomize.com | For Inquiry : 87390 87390





Best Performance Award
IPMA Award 2019

NEW PRODUCT

ડોનેક્સ સર્ફેસ પ્રોટેક્ટર

DONEX SURFACE PROTECTOR 1:7

PINK LIQUID

આ લિક્વિડ ૧ ભાગ + ૪ ભાગ પીવાનું પાણી = કુલ ૫ ભાગ કરવું.
સબમર્શીઅલ મોટરમાં ભરો, ટેસ્ટીંગ કરો, કાઢી નાખો અને રિચુઝ કરો
આમ કરવાથી, ડીલર ને ત્યાં ૧ વર્ષ પડી રહેલી મોટર્સ પણ ચોક-અપ કે જામ નહિ થાય તેથી રિપ્લેસમેન્ટ ઘટશે.

Dilution Ratio For Self Priming pump filling purpose-1+7 = 8

MAHIR®

Surface Protector

SUBMERSIBLE PUMP GRADE - 1:3

For permanent motor filling purpose



- Non Amines Liquid
- Extra Lubrication
- Always free flowing
- Anti-Corrosive Liquid

• NO SIDE EFFECTS ON RUBBER TAPE •

- Best Cooling Properties
- Long Life to inside parts
- Nearly food Grade
- Saves Small Electricity

Some of Our Valued Customers

- Texmo-Taro • Texmo - Aquasub • CRI Pumps • Kirloskar • Varuna • Plugra (Franklin - USA)
- Lubi • Samudra • Laxmi - LADA • Panelli - Italy • Unnati • Hayat • Silver • Ajanta • Angel
- Duke • Oswal • Teraflo • Flotech • Rotec • Aden • Penguin etc. So many pump Mfg. companies.



Manufactured by :
Gokul Coolant Industries
310, PANORAMA COMPLEX, OPP. BAL ADARAT, GOKDAL ROAD, RAJKOT - 360002 (Guj.)
M: +91-281-2233750 | M: +91-90811-96950 | Email: info@rdcoolant.com | www.rdcoolant.com



An Anti-Corrosive Cooling Liquid With Extra Lubrication



+91 99251 04296

info@nandiniind.com

www.nandiniind.com

Atika Ind. Area-2, Opp. Kisan Way Bridge, Atika Dhebar Road(South) Rajkot-2.

Mfg. ALL TYPE OF C.I. CASTING

Molding Process

- Molasses Sand Casting
- Green Sand Casting
- Nobake Casting
- Shell Core Casting

Auto Parts Hydraulic Parts



Fire Safety Hydrant Valve Body

Grinder & Induction Motor Body Parts



Pump Housing Casing Flange

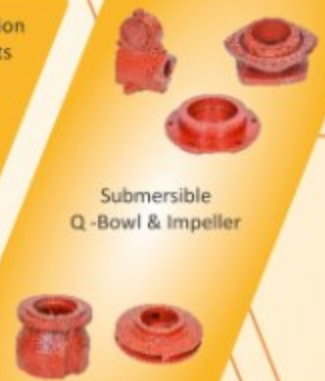

Submersible Q-Bowl & Impeller

Machine Tools



MEERA CASTING

Mfg. : All Kind of C.I. & S.G. Casting

Induction Motor



Gear Box



Industries served

- Electric motor
- Machine tools
- Gear box
- Pumps and Valves



Manufacturer of Grey Iron and SG iron with facility like Induction furnace from Inductotherm, Continuous sand mixer and Reclamation from Omega UK, Fully equipped Laboratory containing Spectrometer from Bruker Germany, Microscope from Metalsoft with image analyser, UTM, Hardness Tester, sand testing equipments, Shot blasting, Fettling, Painting booth etc...



Survey No. 167, Kothariya Village Main Road, Village Lothada, Rajkot (Gujarat) INDIA. E-mail : info@meeracasting.com



FLOTECH[®] PUMPS

2050+
Model

0.5 H.P
to
125 H.P



FLOTECH Engineering Pvt. Ltd.

Rajkot (Gujarat) India.

Web. : www.flotechpumps.com, Mo. 9727775733

आपकी हर जरूरत का साथी

Speedwel®



परिवार रहे
स्वस्थ
जब आटा
मिले स्वच्छ



SHEETAL LEHER
AIR COOLERS

गर्मी में सिर्फ
शीतल लहेर
सुपर हिट

SpeedHot

WATER GEYSER

अब स्पीड हॉट गीजर
के साथ गरम पानी
पाना एकदम आसान



Manufacturer & Exporter (An ISO 9001:2015 Certified Company)

GUJARAT FORGINGS PVT. LTD.

Opp. N.S.I.C., 80 Feet Road, Aji Industrial Area, Rajkot - 360 003 (India).

Email: info@fieldmarshalengine.com | Customer Care No. +91 99740 56831/32/34

Web: www.speedwel.com | Follow us: [f](https://www.facebook.com/Speedwel) [i](https://www.instagram.com/Speedwel) [in](https://www.linkedin.com/company/Speedwel) @Speedwel | [yt](https://www.youtube.com/channel/UC...) +91 99740 56831

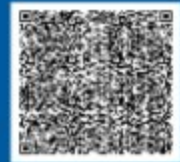

Since : 1982



CE AN ISO 9001:2015 CERTIFIED COMPANY



Manufacturers of :
All Type of ARC Air & Oil Cooled Welding Machine, Spot Welding, Pneumatic Type Spot Welding, Hand Spot Welding, ARC Inverter Welding, Tig Welding, Mig Welding, Plasma Cutting, Welding Equipments & Step-up Transformers.



Regd. Office :
 Plot No. C-D-38, 4, Atika Ind. Area, Weldor Street,
 Kishan Chowk, Dhebar Road (South), RAJKOT-360 002. (INDIA)
 Phone : +91-281-2361937, 2365621, Mob.: 9978975261
 e-mail : rajlaxmiwelding@yahoo.com
 web : www.welding-transformer.com



Always ahead for it's quality, workability & availability



We are an ISO 9001:2015 Company, established in 1983 based in Rajkot and continuously working with Best Quality, Best Price & Timely Deliveries as its mission ever since. SQC is engaged in manufacturing of different types of Investment Castings by lost wax process for Submersible Pumps, Process Pumps, Centrifugal Pumps, Industrial Valves, Cam-Lock Couplings, Aerospace, Agriculture Equipments, Construction Equipments, NRV Couplings, Plumbing Valves, Railways, Marine, General Engineering, Automobiles, Firefighting Range, Food Industries, Dairy & Textile Machineries, Ortho Implants etc. in Ferrous metals such as Stainless steel, Alloy steel, Carbon steel, Duplex steel, Super alloys amongst others and Brass in Non- Ferrous segment.

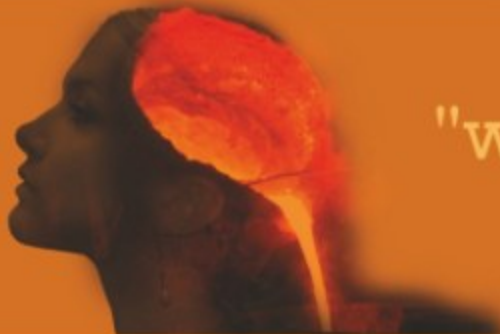

"we Cast What You Think"



- Unit 1 : Behind Rajkamal Petrol Pump, Off Gondal Road, RAJKOT - 360 004. GUJARAT (INDIA)
- Unit 2 : Survey No. 216, Muktidham Road, Before Railway Crossing, Veraval (Shapar) - 360 024. GUJARAT (INDIA)



☎ 91-281-2388848 ✉ info@superqualicast.com 🌐 www.superqualicast.com

Amit Hansalia
+91-99740 38980

An ISO 9001 : 2015 Certified Company

Vijal Gandhi
+91-99740 12322

Shakti

Shakti Heat Treaters & Engineers

Specialist in All type of Heat Treatment process

A Well known and one of the Biggest Heat Treatment Company in the Region
Having More than 100 Customers.

- Forgings
- Investment Castings
- Sand Castings
- S.G. Iron
- C.I. Castings

Machinery

- Gas Fired Pit Type Furnace Temp. 1200 °C
- Gas Fired Pit Type Air Circulated Tempering Furnace
- Electric Pit Type Atmosphere Controlled Carburising Furnace
- Electric Pit Type Air Circulated Tempering Furnace
- Electric Pit Type Air Circulated Solution Treatment Furnace working temp. 1200 °C
- Oil Quenching Tank - 30000 ltr & 12000 ltr
- Water Quenching Tank - 35000 ltr, 15000 ltr & 10000 ltr
- Online Temperature Monitoring Systems

We do

- S.R. Normalizing, Annealing,
- Hardening, Tempering
- Precipitation Hardening, N.Q.T.
- Solution Annealing Upto 1200 °C
- Oil & Water Quenching
- Carburising, Case Hardening

Testing Facility

- Brinell Hardness Tester Computerized
- Rockwell Hardness Tester
- Micro Vickers Hardness Tester
- Portable Hardness Tester
- Microscope

Job Capacity Up to - 1.5 tons Single Pcs
(2300 MM length x 1300 MM Dia)



Office & Works - Unit - 1

Survey No. 163/1-P, Plot No. 3, SIDC Road, Veraval (Shaper) Tal. Kotdasangani, Dist. Rajkot
Phone No.: +91 - 2827- 252067
Email : shaktiheat@gmail.com

Works - Unit - 2

Survey No. 225, Plot No. 39/40/41, Shreenathji Industrial Zone, Near Gundasara Railway Crossing, At. Gundasara Village, Tal. Gondal, Dis. Rajkot

"Manufacture of Best Quality Telescopic Channels"

EISEN

Eisen Hardware Solutions Pvt. Ltd.
100% of Domestic, Indian & International Products
Rajkot (Gujarat) INDIA
www.eisenhardware.com

OEM AVAILABLE



Premium Quality

- Extra Smooth 3 Ball Runner
- Load Capacity 45 kg.
- Long life Locking System
- 120hours slot spary Tested
- Extra Full Extension
- German Technology Plating
- Available Length 10 to 24 inch
- Finish :- Zinc, Black



PC POINT

QUALITY START WITH US.

WE PROVIDE SOLUTIONS

Server, Computer, Laptop Sales & Service

Hardware & Networking Services

Annual Maintenance Contract (AMC)

IP / CCTV Camera Solution / Installation

Network Security Solution

All Type of Corporate Office Communications Solutions (Video Conference System, EPBX, etc)



Sagar Parsana
+91 98981 02907
+91 90333 28628
pcpointcare@gmail.com

"Samrudhi bhavan",
Shop No.74, 3rd floor Gondal rd,
Opp. bombay petrol pump,
Rajkot - 360002



AN ISO 9001 : 2008 Certified Company



Web : www.honestyengworks.com
E-mail : info@honestyengworks.com
Mobile : +91 8000 382199 (KRUNAL)

HONESTY ENGINEERING WORKS

Manu. of High Tensile Bolt, Studs, Nut, Center Bolt & I Bolt

Office: 2, Bhaktinagar Station Road, Rajkot-2. Ph.: 0281-2461040
Factory: 9, Aji Vasahat, 80 Feet Road, Rajkot-3. Ph.: 0281-2389009 Cell : 098240 76100



MANUFACTURERS OF
SCREW TYPE AND RECIPROCATING TYPE
SINGLE STAGE & DOUBLE STAGE
AIR COMPRESSORS

ALSO DEALS IN AIR DRYER, SERVICE PUMP, GREASE PUMP, OIL FREE AIR COMPRESSOR
TRACTOR MOUNTED AIR COMPRESSOR AND OTHER PNEUMATIC ACCESSORIES



Screw Air Compressor Reciprocating Single Stage Single Cylinder Reciprocating Single Stage Double Cylinder Reciprocating Double Stage Double Cylinder



Reciprocating Double Stage Three Cylinder High Pressure Air Compressor Service Pump Grease Pump



Air Drier Tractor Mounted Air Compressor 200H Air Receiver

Office : 99130 00962 Accounts : 94087 09277
Service : 99130 00961 Sales : 99042 99969 96735 35982
Web : www.royo.in Email : info@royo.in

For UNMATCHED Quality PERFORMANCE



टोपलैंड
Topland
توب لاند
topland-india.com

India's "Expert Brand in WATER POWER SOURCING"



हम हैं भारत के नं.1 एवं एकमात्र निरमाता

की आवाजी हर जगह के अनुमान उपलब्ध कराते है।

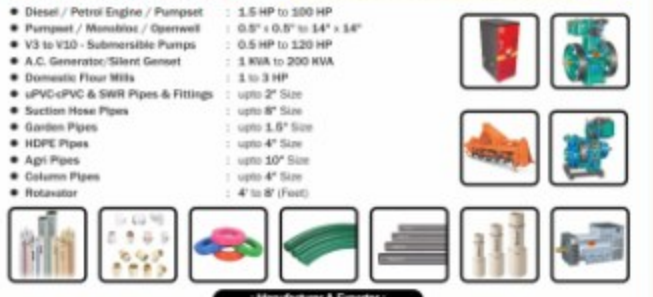

Topland Assorted Product Range :

- Diesel / Petrol Engine / Pumpset : 1.5 HP to 500 HP
- Pumpset / Monobloc / Openwell : 0.5" x 0.5" to 14" x 14"
- V3 to V10 - Submersible Pumps : 0.5 HP to 120 HP
- A.C. Generator/Silent Genset : 1 KVA to 200 KVA
- Domestic Flour Mills : 1 to 3 HP
- uPVC-cPVC & SWR Pipes & Fittings : upto 2" Size
- Suction Hose Pipes : upto 8" Size
- Garden Pipes : upto 1.5" Size
- HDPE Pipes : upto 4" Size
- Agri Pipes : upto 10" Size
- Column Pipes : upto 4" Size
- Rotavator : 4" to 8" (Feet)

Manufacturer & Exporter :
Topland Engines Pvt. Ltd.
2, Umakant Parkit Udhog Nagar, Mavdi Plot, Rajkot - 360 004 (Guj.)
Phone : +91 281 238441/12/3, 238022/23/4 Mobile : +91 90741 25002
E-mail : topland_india@rediffmail.in, info@topland-india.com

Toll Free : 1800 233 88888 AN ISO 9001:2008 Company



RAJKOT ENGINEERING ASSOCIATION

REANA સભ્યોની સવલત અંગેની ઉપલબ્ધિતાઓ

૧. એક્સપોર્ટર માટે સર્ટીફિકેટ ઓફ ઓરીજીન ચાર્જ રૂ. ૧૩૦/- પ્રતિ સર્ટીફિકેટની સવલત.
૨. ઓડિટરીયમની સવલતો
 - A.C. કોન્ફરન્સ રૂમ ૫૦ ની બેઠક સાથે.
 - A.C. બોર્ડ રૂમ ૫૦ ની બેઠક સાથે.
 - A.C. ઓડિટરીયમ ૩૩૦ ની બેઠક સાથે.
 - LED TV / અલ્ટ્રા મોર્ડન સાઉન્ડ સીસ્ટમ, મોટોરાઈઝડ સ્ક્રીન, પ્રોજેક્ટર તથા લેપટોપ સાથેની સવલત.
૩. વિડીયો કોન્ફરન્સીંગ ફેસેલીટી જેમાં ૨૫ સીટીંગ કેપેસિટીની સવલત.
૪. લાયબ્રેરી : ટેકનિકલ, નોન ટેકનિકલ બુક્સ સાથેની અધતન સુવિધા સાથેની લાયબ્રેરી.

ભક્તિનગર ઈન્ડ. એસ્ટેટ જી.આ.ડી.સી.,
શેરી નં.-૩, રાજકોટ.

Mo. 99132 14935 / Email : info@reaindia.com





We are an IATA accredited travel Company. We make your travel economical, safe, fun, informative, comfortable & memorable.

We feel obliged to introduce our ambitious venture "PATEL HOLIDAYS" as an entity which takes care of any tour & travel requirements of its estimated time at global level. Since inception, in 2006, we have been an IATA accredited travel Company.

PATEL HOLIDAYS has been venturing into a new geographic arena and making utmost effort to make the best deal available to its clients.

- Holidays Tour Package (Inbound & Outbound), Family Group Package, Corporate Groups, Dealers Group, MICE & Student Groups, Teacher Groups & Spiritual Tours.
- Airticket (Domestic & International).
- Gulf country VISA stamping including medical.
- Passport processing (New & Renewal) & Student Passports & Groups.
- Travel insurance.
- Worldwide Hotel Bookings.
- Tourist Visa, Business Visa, Conference Visa.

PATEL HOLIDAYS is a one-stop enterprise that offers the complete range of travel related services. Superior knowledge, efficient planning and the ability to anticipate & resolve potential problems along the way are the reasons behind our success.

Till date, we have handled over 50,000 guests who have taken advantage of our valuable services.

We are awarded for the excellent performance of selling Yas Island for the year 2023 by Abu Dhabi Tourism.



MR. SHAILESH PADARIYA
Founder Director
Patel Holidays

Our Expertise

U.K & USA Passport Renewal,
Schengen Visa (Europe), Australia,
Canada, China Tourist & Business Visa)

Specialised In Group Tour

Dubai, Japan, Singapore, Malaysia,
Thailand, Bali, Vietnam, Europe, South
Africa, Himachal, Kashmir, Leh-ladakh,
Goa, Andaman-Nicobar, Kerala,
Karnataka, Uttarakhand, Sikkim.



OUR AWARDS



OUR PRESENCE

- RAJKOT HEAD OFFICE -
3rd Floor - Kevalam Complex,
B/H Umiya Mobile,
Astron Chowk, Rajkot - 360001
☎ +91 98791 24774

- RAJKOT BRANCH OFFICE -
115, Shivam Complex,
Sarweshwar Chowk, Jagnath Plot,
Dr. Yagnik Road Rajkot - 360001
☎ +91 63527 64669 / +91 72850 26577

- AHMEDABAD OFFICE -
612, Aaron Spectra,
Rajpath Rangoli Road,
Bodakdev, Ahmedabad - 380054
☎ +91 96621 61109 / +91 94281 54133

- SURAT OFFICE -
U-4, Jolly Square, Nr. Ram Chowk,
Ghod Dod Road, Surat - 395001
☎ +91 75979 5238 / +91 97261 11880

138, Avadh Viceroy, Sarthana
Jakat Naka, Nana Varachha,
Surat - 395006

- JAMANAGAR OFFICE -
152, Neo Square,
Ambar Cinema, Jamnagar-361001
☎ +91 76983 08248

- JETPUR OFFICE -
IB Complex, Junagadh Rd,
Jetpur - 360370
☎ +91 87348 86500

PATEL HOLIDAYS
TRAVEL SOLUTIONS PVT. LTD.

☎ +91 98791 24774
✉ shailesh.patelholidays@gmail.com



VISHAL

SUBMERSIBLE PUMP SET



Public Rating Grade



ISO 9001:2015 COMPANY



MFG. :
V-3, V-4 SLIM, V-4, V-5,
V-6 BORWELL &
OPENWELL SUBMERSIBLE PUMPSET

VISHAL ENGINEERS
 Golden Industrial Area, Plot No. 6, B/h. Rolex Rings Pvt. Ltd.,
 Railway Crossing, Opp. Krishna Park Hotel, Gondal Road,
 Village : Kothariya - 360 022. Dist. Rajkot.
 E-mail : Vishalengineers2012@gmail.com
 Web : www.vishalpump.com
 Cell : 094271 55599 / 94274 60888 / 099791 11055



Since 1982

Precision Lathe Machines & SPMs

An ISO 9001:2015 Company
known for its accuracy

et 10
High Speed All Geared
Lathe Machines

ACCENT: 100
Heavy Duty All Geared
Lathe Machines

Accurate-8
Heavy Duty
Lathe Machines

Accurate-EXP-K
Extra Heavy Duty
Lathe Machines





Exported to Countries:

ACCURATE MACHINE TOOLS 15, Atika Industrial Area, Phone: +91 261 2361099
 Dhebar Road South, Mobile: +91 98242 22448
 Rajkot - 360 002, INDIA E-mail: info@accuratelathe.com
 www.accuratelathe.com

© ACCURATE - ACCURATE MACHINE TOOLS and SAGTURN are REGISTERED TRADEMARKS. Reproduction, Duplication, Translation, etc. of our Regd. Trademarks are strictly prohibited and legally punishable as per Trademark Act, 1999



VEDANT LOGISTICS

Combining the latest logistics technology with high-quality services, and the ability to offer customised solution

Our Services :

- Export & Import air & sea freight
- Custome Brokerage
- Ad Code Registration
- Self Sealing Permission
- Rex Registration
- Coastal Services
- Transportation

Our Network :

- Kandala
- Mundra
- Nhava Sheva (Mumbai)
- Ahmedabad ICD
- AIR - Ahmedabad
- AIR - Mumbai
- Hazira
- ICD Vernama (Baroda)
- Chennai & Major Ports

CONTACT US :

Registered Office
 Vedant, Geet Gurjari Society,
 Street no. 2, Airport Road, Rajkot -
 360007, Gujarat, India
Email ID
 info@vedantlogistics.co.in
Cell
 +91 90990 12199 / 94080 04365



ISO 9001:2015 Certified Company

Satisfaction of Quality



PRECISION SINTERED PRODUCTS

World Class Manufacturer of
Sintered Bushes & Powdered Metal Structural Parts



Plot No.2611, Lodhika G.I.D.C. Estate, Road - D, Kranti Gate,
METODA (RAJKOT)-360021.(Gujarat, INDIA.)
 Office +91 93774 82888 M. 98253 66380 | 98256 95322
 E-mail : precision@sintered.in | mails@precisionsintered.com
 Web : www.sintered.in | www.precisionsintered.com



Department of Commerce
Ministry of Commerce & Industry
Government of India



#SmartSustainable
Engineering

ORGANISER

EPCINDIA
ENGINEERING THE FUTURE

The 12th Edition of Engineering Sourcing Show



27 28 29 NOVEMBER 2024
CHENNAI TRADE CENTRE, CHENNAI, INDIA

IESS XII would portray

- Technical Sessions, Vendor Development Meets, Global Sourcing Meets
- Focused displays in Technology Pavilion, State Pavilions and Industry Pavilions
- Direct interaction with Manufacturers, Merchants, Entrepreneurs, Academicians, Start Ups, Bureaucrats, Service Providers from engineering background.

Participation charges



Scan for details

ACROSS 4 SECTORS



IESS – A Journey of Innovation and Collaboration



3400 +

Indian Exhibitors



86000 +

Global Visitors



150+

Engineering Product Categories



21

Vendor Development Meets
from **27** Indian Organisations



150 +

Technical Seminars



38

Global Sourcing Meets
from **14** Countries



7,000

B2B Engagements



750 +

Speakers



22

Country, State & UT Pavilions



REGISTER NOW

www.iesshow.in

Contact Us:

C H Nadiger, cnadiger@eepcindia.net, +91 94447 27559

Sudhakaran Nair, snair@eepcindia.net, +91 97256 63534

Mukesh Samtani, msamtani@eepcindia.net, +91 98207 52827

"Don't be a fool - use the proper tools"

SAFETY PRODUCTS | PPE PRODUCTS | FIRE SAFETY
ROAD SAFETY | POWER TOOLS | TOOLS ABRASIVES
WELDING SOLUTIONS | PACKAGING | PAINTS ADHESIVES
HAND TOOLS | ELECTRIC MOTORS



Email : omtrading139@gmail.com | Mo. 72039 00139, 97235 92165
G/911-A, Kishan Gate, Lodhika G.I.D.C., Kalawad Road, Metoda, Dist. Rajkot (Guj)-360021.



Digital Weighing Systems
Matrix

MATRIX WEIGHBRIDGE & INTELLIGENT TERMINAL

PIT LESS WEIGHBRIDGE



PIT MOUNTED WEIGHBRIDGE



MODULAR WEIGHBRIDGE



1 INTEGRATED INTELLIGENT TERMINAL

Product Features

- ✦ Rugged And Robust Design
- ✦ High Record Storage
- ✦ High Strength Structure
- ✦ Designed For Harsh Environment
- ✦ Easy Transportation And Installation
- ✦ Designed And Manufactured Very Precisely
- ✦ Minimum Installation Time
- ✦ Easy Maintenance And Cleaning

Matrix Weighing Systems Pvt. Ltd.
Plot no. 12, Survey no. 32, Rajkot Gondal Highway,
Behind TATA Perfect, Beside Poonam Dumper,
Vavdi, Rajkot - 360 004, Gujarat, INDIA.

Cell.: +91 98250 75183
+91 90990 92850
Email: info@matrixwb.com
Web: www.matrixweighbridge.com



Hand Pallet Truck



- 2500 Kg Lifting Capacity
- Heavy Duty Hydraulic Unit
- Tandem Load Rollers For Easy Movement
- Polyurethane Steering And Castor Wheels For Longer Life
- In Wheel we have 2 option PU & Nylon

- Value for money
- Rugged and reliable
- Long life

Diesel / Electric Forklifts



India's
No. 1
Forklift Truck

- Lift capacity: 1.5 TON to 25 TON
- Lift height: 2100 mm to 5500 mm

Powered Pallet Truck



- Lift capacity: 1.5 TON to 3 TON
- Lift height: 205 mm



MANUAL STACKER

GMS 1016

- Lift capacity: 1000 kg
- Lift height: 1600 mm
- With Adjustable forks



SEMI ELECTRIC STACKER

MS 1024 | MS 1033

Power Lifting function saves time
eliminates manual strain

- Lift capacity: 1000 kg
- Lift height: 2450 mm / 3300 mm



FULLY ELECTRIC STACKER

ES 12XX | ES 15XX

In Fully Electric Stacker 1.2 & 1.5 TON
Capacity Model Available

- Lift capacity: 1200 kg / 1500 kg
- Lift height: 3300mm to 6000 mm

WE CAN ALSO PROVIDE CUSTOMIZED SOLUTION OF MANUAL / SEMI ELE. / FULLY ELE. STACKER

MASCOTTM

CNC Tools & Equipments Pvt. Ltd.

RAJKOT | JAMNAGAR | MORBI

16/28 Vijay Plot, Khodiyar Chowk,
Bhaktinagar, Rajkot-360002 (Gujarat) INDIA.

☎ +91-9737044233

✉ admin.mhe@mascottools.in

Power by Intellect driven by values



www.mascottools.in

GUGAN

SURFACE FINISHING AUTOMATION
AND ELECTROPLATING PEOPLE



SINCE 2014
7 YEARS OF EXCELLENCE
Innovation, Quality, Commitment

About Our Company

Gugan Engineering Company founded in year 2014, set out itself to be a leading solution providers in surface finishing industry. GEC, was formed by first generation entrepreneurs & technocrats. The company has a strong research base with technology, research and development. Gugan Engineering established the state of art manufacturing facility to offer customers and clients the best of technology in industry.

Process lines are specifically designed for all types of surface finishing applications. multiple manufacturing facilities permit flexible customization for every customers need and unique application and delivery requirements.

Our Expertise

- ❖ Alkaline Zinc Plating Plant
- ❖ Zinc Nickel Plating Plant
- ❖ Acid zinc Plating Plant
- ❖ Copper Plating Plant
- ❖ Anodizing Plant
- ❖ Phosphating Plant
- ❖ ABS Plating Plant
- ❖ PCB Plating Plant
- ❖ Silver Plating Plant

Process Automation of Plating Industry

- ❖ Process Efficiency
- ❖ Cycle Optimization
- ❖ Productivity Improvement
- ❖ Mixed Cycle Program
- ❖ ERP / SAP Integration
- ❖ Energy Management in Plating Plants



Contact us for your automatic plating line requirements

GUGAN ENGINEERING COMPANY

No: 60/2A & 61/2A, Chettiyar Agaram Main Road, Chettiyar Agaram, Chennai - 600077
9894164686, 9043896720 | arun@guganengg.com | www.guganengg.com

SINCE : 2000



TOP SAFETY
QUALITY
CUSTOMER
SATISFACTION



LIFT MFG., MODERNIZATION & MAINTENANCE



2,500+
Elevators
Manufactured



400+
Client Base



20+
Cities in India



Our Products :

- Passenger Lift
- Capsule Lift
- Hospital Lift
- Goods Lift
- Dumbwaiter
- Car Lift
- Hydraulic Lift

TOP INDIA ELEVATOR PVT. LTD.

Head Office :

205 - B, Crystal Commercial Complex.,
Nr. K.K.V. Hall, 150 Feet. Ring Road,
Rajkot - 360005. Gujarat. INDIA.

Phone : 0281-2587835

Mobile : + 91 - 9924130748

E-mail : info@topindiaelevator.com

Website : www.topindiaelevator.com

Factory :

G-1127-1128, 1C Road, Lodhika G.I.D.C.
Kishan Gate, Nr. Rajendra Cold Storage,
Kalawad Road, Metoda. Rajkot - 360021
(Gujarat-India) Mobile : +91 99241 96662

Branch Office : Bhavnagar, Surat, Junagadh, Vadodara.



AN ISO 9001:2015 COMPANY
ZMR
SOLAR ENERGY

जल है तो कल है,
ZMR पंप है तो सालो साल है

0.05 hp
to 350hp
2000 feet
Capacity



Domestic, Industrial, Agriculture, Pumps & Motors



Manufactured By
RANJAN INDUSTRIES
Gurukul Road, 8th S.T. Workshop, Sanjal Industrial Area, Opp. Uma International, Rajkot-360004
E-mail: ranjan2549@gmail.com / E-mail: zmrpumps.marketing@gmail.com
Web: www.ranjanindustries.in
Toll-Free No.: 1800 1234 181



AN ISO 9001:2015 COMPANY
ZMR
SOLAR ENERGY

“ऊर्जा के स्रोत को बिना नुकसान पहुंचायेँ ऊर्जा प्राप्त करना”



Solar Residential & Industrial Rooftop, Ground Mount Power Plant, Solar Water Pumping System



Manufactured By
RANJAN INDUSTRIES
Gurukul Road, 8th S.T. Workshop, Sanjal Industrial Area, Opp. Uma International, Rajkot-360004
E-mail: ranjan2549@gmail.com / E-mail: zmrpumps.marketing@gmail.com
Web: www.ranjanindustries.in
Toll-Free No.: 1800 1234 181



Manoj Bhalala
98242 31034



**PRAMUKH
INSTRUMENTATION**

“MOHAN KUNJ”, 2-Bhakti Nagar Station Road, Rajkot-360 002.
Cell : 94290 49123, 75679 49798 | Email : pramukh.ins@gmail.com



INDUSTRIAL
CHOICE FOR

Interior | Appliances
Furniture | Machinery

MANUFACTURED BY
LUXURIA PAINTS

Office : Sanskar Industrial society Main Road,
Nr, National Highway 8-B, Rajkot - 360003.
Factory : Plot No. 40 to 44 & 55 to 57 Survey No.: 251 to 255
Gokul Industrial Park - 2, Taluka: Kotda sangani,
Village Piplana, Rajkot - 360024 (Gujarat) India.
Customer Care No.: 8181981814, 9009007256
E-mail : info@luxuriapaints.com



One Stop Solution

FOR ALL KINDS OF ENGINEERING CUTTING TOOLS, TAPS, CBN/PCD INSERTS AND INDUSTRIAL LUBRICANTS



HSS-E & HSS Taps

OUR PRODUCT PORTFOLIO INCLUDES

MEBA
sawing solutions.
Bimetal Bandsaw Blades
Bandsaw Blades &
Circular Saw Cutters

MEBA
sawing solutions.
Bandsaw Machines &
Circular Saw Machines

MAGNACOO
Quality | Performance | Value
Industrial Oil
Industrial Lubricants
Industrial Cutting Oil

Member IAC Group
icent
CNC & VMC Tooling Solutions

ALFA
BIMETAL BANDSAW BLADES
M42 & M51 Grade Bandsaw Blades

DRISHTY-24

JE JAY ENTERPRISE

Partners In Providing Cost Effective Solutions

📍 12/4, Bhaktinagar Station Plot, Rajkot-360 002.

☎ +91 63546 04954/ 97146 77788

✉ jay.ent.pr@gmail.com / manish@jayrjt.com



B. M. Enterprise

Partners In Journey Of Excellence

OUR PRODUCT PORTFOLIO INCLUDES

ONE STOP SOLUTION FOR ALL KINDS OF VENTILATION, COMPLETE SAWING, KNURLING, DRILLING & TAPING.



- Bandsaw Blades
- Circular Saw Cutters

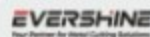

- Bandsaw Blades
- Bandsaw Machines



- HSS & M35 Drills
- Center Drills & Endmils



- Bandsaw Machine
- Circular Saw Machines



- Knurling Tools
- Knurling Die



- Industrial Lubricants
- Cutting Oil

DRISHTY-24

📍 "Sureshwar Nivas", 12/4, Bhaktinagar Station Plot, Rajkot -360 002

☎ +91 99257 12427, +91 63546 04954, ✉ :bmenterpriserjt@gmail.com



SN AUTOMATION

Manufacturing & Supplying Of

- Spring Conveyor
- Magnet Conveyor
- Hinge Belt Conveyor
- Gravity Roller Conveyor
- Scraper Belt Conveyor
- Screw Conveyor
- Truck Loading Conveyor
- Centralized Conveyor
- Mess Belt Conveyor
- PVC Belt Conveyor
- Rubber Belt Conveyor
- S.S Tank

SN AUTOMATION

Survey No 17, Plot no 3 And 4,
Behind Pentagon Forge, Gondal Road NH, Ta - Gondal,
Dist - Rajkot, AT BHARUDI, Pin-360311

Mob: 99137 39903 , 99254 56848
E-mail: snautomation@live.com,
snautomation.in@gmail.com
Web: www.snautomation.in



king
PIPES & FITTINGS
SINCE 1996

27 SAAL SE
PIPE KA KING
KING PIPES



Plumbing / Drainage / Agriculture / Sanitary

KING POLYPLAST PVT. LTD.
Opp. Taluka Seva Sadan, Rajkot-Jamnagar Old Highway,
Padshan - 360 110, Dist. Rajkot, Gujarat (INDIA).
www.kingpipes.in | info@kingpipes.in



plasma
Nature Grows Naturally



PLASMA ALLOYS PVT. LTD

Specialized Ductile Iron Casting Foundry
With Distinctive Capabilities of
SIMo, ADI & SSFDI Grades

Address :
Plasma Gate, Plot No. 1,2,3 & 4, Revenue Survey No. 195,
Shapar - veraval, Taluka : Kotda Sangani, District : Rajkot - 360024
Email : info@plasmaalloys.com, Web : www.plasmaalloys.com
Contact : +91 97373 60666 / 82383 17777



RAJKOT ENGINEERING ASSOCIATION

REAAના સભ્યોની સવલત અંગેની ઉપલબ્ધિતાઓ

1. એક્સપોર્ટર માટે સર્ટીફિકેટ ઓફ ઓરીજીન ચાર્જ રૂ. 130/- પ્રતિ સર્ટીફિકેટની સવલત.
2. ઓડીટરીયમની સવલતો
 - A.C. કોન્ટ્રોલ રૂમ 40 ની બેઠક સાથે.
 - A.C. બોર્ડ રૂમ 40 ની બેઠક સાથે.
 - A.C. ઓડિટરીયમ 330 ની બેઠક સાથે.
 - LED TV / અલ્ટ્રા મોર્ડન સાઉન્ડ સીસ્ટમ, મોટોરાઈઝ્ડ સ્ક્રીન, પ્રોજેક્ટર તથા લેપટોપ સાથેની સવલત.
3. વિડીયો કોનફરન્સિંગ ફેસેલીટી જેમાં ૨૫ સીટીંગ કેપેસિટીની સવલત.
૪. લાયબ્રેરી : ટેકનિકલ, નોન ટેકનિકલ બુક્સ સાથેની અદ્યતન સુવિધા સાથેની લાયબ્રેરી.

ભક્તિનગર ઇન્ડ. એસ્ટેટ જી.આ.ડી.સી.,
શેરી નં.-૩, રાજકોટ.
Mo. 99132 14935 / Email : info@reaindia.com



શું આપ રાજકોટ સ્થિત વિશ્વ ફલક નોંધનીય તથા હશેરના જુનામાં જુના અને અતિ કાર્યશીલ એવા આપણાં રાજકોટ એન્જીનીયરીંગ એસોસીએશનના સભ્ય છુઓ?????

અહીં ઉદ્યોગોના પોષણ અને પ્રોત્સાહન માટે વિવિધ સેમીનાર, માસિક મેગેજીન, સોશિયલ મીડિયા અન્ય માધ્યમો ટેકનોલોજી સાથે સમન્વય સાધીને ઉદ્યોગ-ધંધાને સ્પર્શતી સચોટ માહિતી આપવામાં આવે છે.

સરકારશ્રીની એસોસીએશનના માધ્યમ થી સામૂહિક યોજનાઓનો લાભ ઉઠાવવાની તકો પુરી પાડવામાં આવે છે.

રાજકોટ એન્જીનીયરીંગ એસોસીએશન સાથે જોડાવા માટે આજે જ સંપર્ક કરો... ૯૯૧૩૨ ૧૪૯૩૫

Scan & Contact



RAJKOT ENGINEERING ASSOCIATION

Bhaktinagar Industrial Estate, G.I.D.C., Street No.-3, Rajkot-360 002.

Ph. : +91-281-2362235 / 36, Mo. +91 99132 14935

E-mail : info@reaindia.com

Website : www.reaindia.com



AN ISO 9001:2015 COMPANY

KHODIYAR

INDUSTRIAL PVT. LTD.

BELT CONVEYOR ROLLER, IDLERS & GEAR BOX









Plot No. 456 to 4604, Golden Green Industrial City, Mavdi-Pal Road,
Near Makhawad Chowk, Village-Khanbha, Tal- Lodhika, Khambha,
RAJKOT, Gujarat - 360311 (India) Mo. : 96875 67045

info@kic.co.in | www.kic.co.in / www.kicindia.in

MANUFACTURER OF CONVEYOR BELT AND CONVEYOR IDLERS



TRUST IN THE NAME

Since 1985



Aal Shree KHODIYAR

(CERTIFIED COMPANY)
(ISO 9001:2015 REGISTERED CERTIFIED COMPANY)



BETTER FOR SPECIAL EXPORT CONSIGNMENT

AMD ICD
AMD AIR PORT
KANDLA PORT
MUNDRA PORT

J.N.P.T. PORT
NHAVA SHEVA
DRONAGIRI
SAHARA CARGO (ANDHERI)

CORPORATE OFFICE
Power Industrial, R.S.No-250, Plot No-38+39/2-Shed No.1,
Kothariya Solvant, Rajkot - 360022.
Contact Us :
+91 971-425-8789 +91 957-439-9909

VISIT US at : www.askrgroup.com MAIL US at : askhodyarroad@gmail.com

Business Insurance



Smart way to save Tax & Take Growth on Tax

Organization that can take advantage



01 Public Limited Company



02 Private Limited Company



03 Limited Liability Partnership



04 Partnership Firm



05 Proprietorship Firm



06 Trust Societies & Others

Let's Understand

Note : The below individuals will not be considered as an employee of the organisation:

Proprietor of a proprietorship Firm | Partners in a Partnership/LLP

Contractual Employees | Trustee of a Trust

Types Of Business Insurance

■ Keyman ■ Partnership Insurance

■ Employer - Employee

No Impact of Budget '23 - As **Business Insurance** Remains outside the Scope of 10 - 10(d)

Premium paid is **Business expenses** under section 37(1) of Income Tax Act, 1961

Ex -gratia / compensation given to deceased employee's legal heir is tax free in the hands of family (as per CBDT Circular 573)

FIKAR
FREE Life

Contact : Anika Sangghvi M. +91 98339 77000



RAJKOT ENGINEERING ASSOCIATION

DIRECTORY 2024-2025 & BULLETIN RATES

SR. NO.	ADVERTISEMENT TYPE	DIRECTORY SIZE & CM (W X H)	BULLETIN SIZE IN CM (W X H)	DIRECTORY RATE	BULLETIN RATE <small>April 24 to March 26</small>
---------	--------------------	-----------------------------	-----------------------------	----------------	--

PREMIUM SECTION

1	BACK PAGE	15 x 23	20 x 26	185000	150000
2	FIRST PAGE INNER	15 x 23	20 x 26	115000	140000
3	BACK PAGE INNER	15 x 23	20 x 26	99000	125000
4	ALL PAGE BOTTOM LINE STRIP	1 line + logo	1 line + logo	99000	80000
5	OPP. FIRST PAGE INNER	13.25 x 21	-	60000	-
6	OPP. BACK PAGE INNER	13.25 x 21	-	40000	-
7	FULL FLIP PAGE	27 x 23	37 x 26	90000	220000
8	HALF FLIP PAGE	21 x 23 + 6x23	20x26 + 10x26	60000	115000
9	POINTER FULL PAGE	13.25 x 21	-	45000	-
10	TAG - BOOKMARK	7 x 15	-	50000	-
11	PREMIUM FULL PAGE COLOR	13.25 x 21	-	35000	-
12	PREMIUM FULL PAGE + PROFILE	13.25 x 21	-	50000	-

COLOR SECTION

1	PIN PAGE (2 PAGE)	13.25 X 21	18 x 24	50000	125000
2	FULL PAGE + PROFILE	13.25 X 21	18 x 24	45000	110000
3	FULL PAGE COLOR	13.25 X 21	18 x 24	28000	75000
4	HALF PAGE COLOR	13.25 X 10.25	18 x 12	16000	40000
5	QUARTER PAGE COLOR	6.5 X 10.25	9 x 12	10000	27000

B/W SECTION

1	PIN PAGE (2 PAGE)	-	18 X 24	-	75000
2	FULL PAGE + PROFILE B/W	-	18 X 24	-	60000
3	FULL PAGE B/W	-	18 X 24	-	40000
4	HALF PAGE B/W	-	18 X 12	-	27000
5	QUARTER PAGE B/W	-	9 X 12	-	15000

બુલેટીન જાહેરાત માટેની અસત્યની સુચનાઓ :

- જાહેરાત સંપર્ક માટે "ગુજરાત એન્ડ એન્ડ મીડીયા" ના મો. ૯૩૩૩૩ ૯૩૩૭૫ પર કરવાનો રહેશે.
- પેમેન્ટ "રાજકોટ એન્જીનીયરીંગ એસોસીએશન" Payable at per Rajkot નો ચેક/ડી.ડી. થી આપવાનો રહેશે.
- જાહેરાત પસંદગીની જગ્યા વહેલા તે વહેલાના ધોરણે આપવામાં આવશે.



સંસ્થા સમાચાર

- ❖ **રાજકોટ એન્જી. ઈન્ફો. બુલેટીન આર.એમ.એસ. દ્વારા મોકલાવેલ :**
આર.ઈ.એ.નું માહે સપ્ટેમ્બર-૨૦૨૪ નું બુલેટીન પોસ્ટ ખાતાના આર.એમ.એસ. દ્વારા તા. ૧૦-૯-૨૦૨૪ ના રોજ સભ્યો ને મોકલવામાં આવેલ.
આર.ઈ.એ.નું માહે સપ્ટેમ્બર-૨૦૨૪ ના બુલેટીનની લિન્ક તા. ૧૨-૯-૨૦૨૪ ના સભ્યોને મોકલવામાં આવેલ.
- ❖ **REA પોસ્ટ ઓફીસ રાજકોટ ડીવીઝનને પત્ર મોકલાવેલ :**
રાજકોટ એન્જીનીયરીંગ એસોસીએશનના મેમ્બર્સ મે. તત્વન એલુમીકાસ્ટ પ્રા.લી. ને બુલેટીન ન મળવા અંગે આર.એમ.એસ. પોસ્ટને તા. ૧૨-૯-૨૦૨૪ ને પત્ર મોકલાવેલ.
- ❖ **ACMA ન્યુ દિલ્હી ને પત્ર મોકલાવેલ :**
ઓટોમોટીવ કોમ્પોન્ટ મેન્યુફેક્ચર્સ એસોસીએશન ઓફ ઈન્ડિયાની મેમ્બરશિપ નોંધણી અંગે જરૂરી ડોક્યુમેન્ટ તા. ૧૧-૯-૨૦૨૪ ના રોજ પત્ર દ્વારા મોકલાવેલ.
- ❖ **GERC ગાંધીનગરને પત્ર મોકલાવેલ :**
તા. ૩૧-૮-૨૦૨૪ ના રોજ જારી કરાયેલા અમેન્ડમેન્ટ માં ચાર્જ સુધારાની વિગત અંગે GERC ગાંધીનગરને તા. ૧૧-૯-૨૦૨૪ ના રોજ પત્ર મોકલાવે.
- ❖ **મુખ્યમંત્રીશ્રી ગાંધીનગરને પત્ર મોકલાવેલ :**
KOREA METAL WEEK-2024 ૧૬ ઓક્ટોબર થી ૧૮ ઓક્ટોબર ૨૦૨૪ દરમ્યાન સાઉથ કોરિયામાં થવા જઈ રહ્યો છે જેના ઉદ્ઘાટન સમારોહમાં હાજરી આપવા તા. ૧૯-૯-૨૦૨૪ ના રોજ પત્ર મોકલાવેલ.
- ❖ **MSME મિનિસ્ટ્રી ને ઈમેઈલ મોકલાવેલ :**
રાજકોટ એન્જીનિયરીંગ એસોસીએશનનું ડેલિગેશન KOREA METAL WEEK-2024 ૧૬ વોક્ટોબર થી ૧૮ ઓક્ટોબર ૨૦૨૪ દરમ્યાન સાઉથ કોરિયામાં થવા જઈ રહ્યો છે. તેની મંજૂરી અંગેનો પત્ર Mrs. MERCY EPAO (Jt. Secretary MSME) ને તા. ૨૦-૯-૨૦૨૪ ના ઈમેલ દ્વારા મોકલાવેલ.

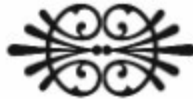



Chirag Shah
098240 28131

We are Dealing In :

IPA (ISO PROPYL ALCOHOL)
AEROSOL OT (DI OCTYL SODIUM
SULHOSUCCNATE)
1 OCTANOL
MEK (METYL ETHYL KETON)
PETROLIUM JILLY
2 ETHYL HEXNOL
LABORATORY CHEMICALS N GLASS WEAR
GLASS PARTS OF CARBON SULPHUR
APPRATUS N CONSUMABLE

BHUMI
SCIENTIFIC INC

Reg. Office : A/7, Sumel Flats, Nr. Shreyash Crossing,
Ambawadi, Ahmedabad - 380015 INDIA

Office : C-27, Maruti Ind. Estate, Opp. Kirti Tools,
Ph 1, GIDC Vatva, Ahmedabad - 382445 INDIA



:: એક્ષપોર્ટ્સ માટે સર્ટીફિકેટ ઓફ ઓરીજન ચાર્જસ ::

“સર્ટીફિકેટ ઓફ ઓરીજન” મેળવવા માટે નીચે મુજબ ચાર્જ રાખવામાં આવેલ છે.

REA મેમ્બર્સ

રૂા. ૧૩૦/-

પ્રતિ સર્ટીફિકેટ



કાર્ય સારાંશ

❖ માહે સપ્ટેમ્બર ૨૦૨૪ ની બોર્ડ ઓફ ડાયરેક્ટરની મીટીંગ મળેલ :

આર.ઈ.એ. ની માહે સપ્ટેમ્બર ૨૦૨૪ ની બોર્ડ ઓફ ડાયરેક્ટરની મીટીંગ પ્રમુખ શ્રી નરેન્દ્ર પાંચાણીના અધ્યક્ષ સ્થાને તા. ૨૭-૯-૨૦૨૪ ના રોજ સાંજના ૬-૦૦ કલાકે બોર્ડરૂમમાં મળેલ મીટીંગના એજન્ડા મુજબ તા. ૧૪-૮-૨૦૨૪ ની ગત મીટીંગની કાર્યવાહી નોંધ વાંચી સંભળાવવામાં આવેલ જેને સર્વાનુમતે મંજૂર રાખવાનું ઠરાવવામાં આવેલ. એજન્ડા મુજબના મુદ્દાઓની વિસ્તૃત ચર્ચા વિચારણા કરવામાં આવેલ જેને સર્વાનુમતે બહાલ રાખવાનું ઠરાવવામાં આવેલ.





રાજકોટ એન્જીનીયરીંગ એસોસીએશન દ્વારા ભારત સરકારશ્રીના વાણિજ્ય મંત્રાલયના સહયોગથી ઈ.ઈ.પી.સી. ઈન્ડિયા, રાજકોટ એન્જીનીયરીંગ એસોસીએશન તથા આર.બી.આઈ. બેન્કના સહયોગથી તા. ૨૪-૯-૨૦૨૪ ના મંગળવારના રોજ રાજકોટ એન્જીનીયરીંગ એસોસીએશનના ઓડીટરીયમ ખાતે સમય સવારના ૯-૩૦ થી બપોરના ૧-૩૦ દરમિયાન "Seminar on Exploring Export Opportunities in Engineering Industries & Business Opportunities In International Engineering Sourcing Show" સેમીનારનું આયોજન કરવામાં આવેલ. આ સેમીનારમાં મુખ્યત્વે નિકાસને લગતી બાબતો અંગે તજજ્ઞો દ્વારા માર્ગદર્શન આપવામાં આવેલ જેમા મુખ્યત્વે એક ઉત્તમ નિકાસકાર કેવી રીતે બનાવવો એન્જિનિયરિંગ ઉદ્યોગોમાં આંતરરાષ્ટ્રીય ઈજનેરી સ્ત્રોતોમાં વ્યવસાયની તકોનો સમાવેશ કરવામાં વગેરે વિષયો અંગે માહિતી આપવામાં આવેલ.

આ સેમીનારમાં DGFT ના જો. ડાયરેક્ટર, અમદાવાદના શ્રી રોહિત સોની, કોર્પોરેટ ટ્રેઈનર, એક્સપોર્ટ ઈમ્પોર્ટ બિઝનેશ કન્સલ્ટીંગ ના તજજ્ઞ શ્રી કેતના ચાંગાણી દ્વારા "એન્જિનિયરીંગ ઉદ્યોગોમાં તકોની શક્યતાઓ - અંગે માર્ગદર્શન આપવામાં આવશે તેમજ આર.બી.એલ. બેન્ક ના ઝોનલ વડા શ્રી રીતેશ શાહ તથા શ્રી વિજેરાઘવન દ્વારા નિકાસ માટે નાણા વ્યવસ્થા અને નવીનતા બાબતે માર્ગદર્શન આપવામાં આવેલ.

ઉદ્યોગકારોને નિકાસને લગતી સંપૂર્ણ પ્રકારની જાણકારી વિના મૂલ્યે આપવા માટે ભારત સરકારશ્રીના વાણિજ્ય મંત્રાલયના EEPC દ્વારા સેમીનારનું આયોજન કરવામાં આવેલ જેમાં રાજકોટ એન્જીનીયરીંગ એસોસીએશન ના પ્રમુખશ્રી નરેન્દ્ર પાંચાણી અને EEPC ના રાજકોટ ચેપ્ટરના કન્વીનર શ્રી સમીર વૈષ્ણવ ઉપસ્થિત રહેલ. રાજકોટ તેમજ સૌરાષ્ટ્ર વિસ્તારના સાહસિકોએ આ સેમીનારમાં ઉપસ્થિત રહીને સારી જાણકારી મેળવી હતી.





❖ વર્લ્ડ હાર્ટ ડે નિમિત્તે હેલ્થ ચેકઅપ કેમ્પ :



❖ વર્લ્ડ હાર્ટ ડે નિમિત્તે હેલ્થ ચેકઅપ કેમ્પ :

રાજકોટ એન્જીનિયરીંગ એસોસિએશન દ્વારા સિનર્જી સુપર સ્પેશ્યાલીટીના સહયોગથી તા. ૨૯-૯-૨૦૨૪ ના વર્લ્ડ હાર્ટ ડે નિમિત્તે હેલ્થ ચેકઅપ માટેનું રખાયેલા કેમ્પનું આયોજન કરાયેલ જેમાં ડો. જયેશ ડોબરીયા, ડો. માધવ ઉપાધ્યાય, ડો. નિલેઈ માંકડિયા વિગેરે સીનર્જી હોસ્પિટલ ટીમના ડોક્ટરો હાજર રહેલ. સાંજે ૪-૦૦ વાગ્યાથી જુદા જુદા ચેકઅપ કરવામાં આવેલ અને સંપૂર્ણ ફ્રી ચેક અપ કરવામાં આયોજીત નિ:શુલ્ક નિદાન કેમ્પ યોજવામાં આવેલ જેમાં બહોની સંખ્યામાં લોકોએ ભાગ લીધો હતો. આજની દોડધામવાડી લાઈફમાં હાર્ટને લગતી સમસ્યાઓ થી કઈ રીતે બચી શકાય તે અંગે સીનર્જી હોસ્પિટલના ડોક્ટરોની ટીમ દ્વારા માહિતી આપવામાં આવેલ. નિયમિત ખાન-પાન તેમજ જીવનશૈલીમાં બદલાવ લાવવામાં આવે તો રોગમુક્ત રહી શકાય.



(RETARC) RAJKOT ENGINEERING TESTING AND RESEARCH CENTRE

NABL & BIS Approved Pumpset Test Facility

NABL ACCREDITED

મુબજ વ્યાજબી દરે એકજ વર્ષમાં
NABL અને **BIS** માન્ય લેબ
રિપોર્ટ આપવામાં આવશે.

આપની પ્રોડક્ટનું ટેસ્ટિંગ હવે ધી
આપણી એસોસીએશનની લેબમાં
પંપસેટ ટેસ્ટિંગ કરાવી શકો છો.

BIS (આઈ. એસ. આઈ.)
લેવા માટે પંપસેટ
ઉત્પાદકોને જરૂરી માર્ગદર્શન અને
ટેસ્ટિંગની અધ્યતન
સુવિધાઓ ધી સજજ.

BEE (હટાર રેટિંગ) માટે
ગુણવત્તા મુક્ત પંપસેટ ટેસ્ટિંગ
માટેની અધ્યતન સુવિધાઓ
ધી સજજ.

FOR INQUIRY & COMMUNICATION KINDLY CONTACT US

Address: Plot 372, Aji GIDC, O-road, Rajkot-360003

Mobile No: 7069728109 / 9328538994

E-mail: info.retarc@gmail.com

Web: www.reaindia.com/retarc.html

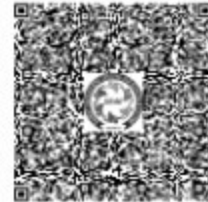



® REA - Rajkot Engineering Association,
3, Bhaktinagar Industrial Estate (GIDC),
Rajkot- 360002, Gujarat, India
Website: www.reaindia.com
Mail: info@reaindia.com
Contact: +91-9913214935, +91-281-2362235/36

**Bharat
Mobility**
GLOBAL EXPO 2025



ACMA Mobility Foundation

Auto Expo -2025 The Components Show ખાસ અંક

નવી દિલ્હીમાં વિશ્વ વિખ્યાત પ્રદર્શન "Auto Expo -2025" થવા જઈ રહ્યો છે . આ એક્સપોનું નામ ભારત મોબિલિટી ગ્લોબલ એક્સપો -2025 થઈ ગયેલ છે અને નવું સ્થળ યશોભુમિ દ્વારકા ખાતે થવા જઈ રહ્યું છે. આ એક્સપો (Auto Expo The Components Show) માં રાજકોટ એન્જીનીયરીંગ એસોસિએશન દ્વારા અંદાજિત ૫૦૦ ચો . મીટર નું પેવેલીયન બુક કરાવેલ છે.

રાજકોટ એન્જીનીયરીંગ એસોસિએશન ના પેવેલીયનમાં " રાજકોટ એન્જીનીયરીંગ ઇન્ફોર્મેશન બુલેટીન " અંકમાં ખાસ ઓટોમોબાઇલ્સ ઇન્ડસ્ટ્રીઝને દેશ અને વિદેશમાં મોખરાનું સ્થાન મળે એ આશયે ખાસ ઓટોમોબાઇલ્સ ઉદ્યોગોની પ્રસિધ્ધિ અને બ્રાન્ડીંગ થાય એ માટે આકર્ષક જાહેરાત જાન્યુઆરી-2025 ના બુલેટીન અંકમાં રાખવામાં આવેલ છે અને જેનું વિતરણ આ **Auto Expo -2025 એક્ઝીબીશન દરમ્યાન** રાજકોટ એન્જીનીયરીંગ એસોસિએશનના પેવેલીયનમાં વિતરણ કરવામાં આવશે. જેના જાહેરાતના દર પ્રિન્ટીંગ કોસ્ટ મુજબજ રાખવામાં આવેલ છે. જેથી રાજકોટના નામી ઉદ્યોગ એકમો આ તકનો લાભ લઈ એસોસિએશનને સહયોગ આપી તેમના એકમોની વિશ્વ સ્તરે પ્રસિધ્ધિ મેળવવા આગળ આવે એવો અનુરોધ કરવામાં આવે છે.

: **Auto Expo -2025 સ્પે. બુલેટીન માટેના જાહેરાતના દર :**

- 1- Full Page – Color - Rs. 6,500/-
- 2- Half Page - Color - Rs. 3,500/-

ઓટો એક્સપો ખાસ અંક માટેની અગત્યની સૂચનાઓ :

- ૧- બુલેટીન અંક ની સાઇઝ : Full page (૧૮ X ૨૪) Half page (૧૮ X ૧૨) in CM
- ૨- જાહેરાતની મેટર CDR, PDF, EPS, (Convert to Curves) સાઇઝમાં આપવાની રહેશે.
- ૩- પેમેન્ટ " રાજકોટ એન્જીનીયરીંગ એસોસિએશન " Payable at per Rajkot નો ચેક / ડી. ડી. થી આપવાનો રહેશે.

➤ રાજકોટ એન્જીનીયરીંગ એસોસિએશનની બેંક ડીટેઇલ : **Bank of India**

Bhaktinagar SSI Branch – Rajkot
A/C. No. 312120110000222
IFSC Code BKID0003121

નોંધ : આ અંગેની વિશેષ માહિતી માટે રાજકોટ એન્જીનીયરીંગ એસોસિએશનના મો. નંબર ૯૯૧૩૨૧૪૯૩૫ ઉપર સંપર્ક કરવા વિનંતી છે.



“આર.ઈ.એ. ના સભ્યો તથા પરિવારગણ માટે મેડીકલ સારવાર માટે એમ.ઓ.યુ. કરેલ”



RAJKOT ENGINEERING ASSOCIATION



- A. OPD In-house consultation માટે ડીસ્કાઉન્ટ ૨૦%
- B. For Investigation OPD offer 20% discount, For Procedures during OPD Offer 20% Discount
- C. For IP Admissions, Excluding Out sources services, Pharmacy, Cashless Health Insurance services and consumables etc. offer 12% Discount.



નેત્રદીપ આઈ હોસ્પિટલ

- A. IPD માટે રૂપે. ડીસ્કાઉન્ટ ૧૦%
- B. OPD In-house consultation માટે રૂપે. ડીસ્કાઉન્ટ ૫૦%
- C. OPD In-house consultation માટે રૂપે. ડીસ્કાઉન્ટ ૨૦%



SYNERGY
SUPERSPECIALITY
HOSPITAL

સિનર્જી હોસ્પિટલ

- A. OPD In-house consultation માટે રૂપે. ડીસ્કાઉન્ટ ૧૦%
- B. Total hospitalization bill excluding pharmacy, consumables and outsourced services માટે રૂપે. ડીસ્કાઉન્ટ ૧૦%
- C. Health Checkup Package in Hospital માટે રૂપે. ડીસ્કાઉન્ટ ૧૦%
- D. OPD in house investigations માટે રૂપે. ડીસ્કાઉન્ટ ૧૫%



Paresh Rangani
+91 82645 57951



STEEL
ALLOY STEEL
CASTING PARTS

NEON ENTERPRISE

Address : Mani Nagar-3, Nr. Ashok Garden,
Mavdi plot, Rajkot - 360004.

Email : neonenterprise93@yahoo.com

હિરેન ધારૈયા CNC પ્રોગ્રામિંગ ક્લાસિક્સ

હાર્દિક ધારૈયા
95742 61002

CNC

પ્રોગ્રામિંગ શીખો

CNC મશીન ઉપર
પ્રેક્ટીકલ સાથે

ISO
પ્રમાણિત
સંસ્થા



MAA Quality Inspection Services

- **Competent Person under Factory Act**
Inspection of Hoist and Lifts and Certification in Form No: 99 – LIFT INSPECTION CERTIFICATION
- **Inspection of Lifting Tools and Tackles Certification in Form No: 10 – CHAIN BLOCKS, D SHAKLES, ALL TYPES OF CRANES – EOT, HYDRAULIC MOBILE CRANE, CRAWLER, TOWER CRANE, GANTRY CRANE, HYDRA, FORK LIFT, EYE BOLT, SLING, ELECT HOIST, STACKER, FORK LIFT, WINCH, PLATE CLAMP, MONORAIL, HOOK CHOOK.**
- **Inspection external & internal examination & hydraulic testing of pressure vessels/plants etc and Certification in Form No: 11 – AIR RECEIVER, REACTOR, OIL EXPELLER, PRESSURE VESSEL.**
- **Inspection for Safety against rotating/moving machinery, power presses, Centrifugal Machines, Dangerous Machines and Certification – POWER PRESS, CENTRIFUGAL MACHINE**
- **Inspection of Dust/Fume Extraction/Ventilation System, Dangerous Process, exposure of workman etc. and Certification in Form No: 26A – FOUNDRY PLANT, PAINT SHOP**
 - Chartered Engineer Certification
 - Govt/Approved Valuer- Plant and Machinery
 - DISH Approved Safety Training as per requirement
 - Legal Safety Audit as per IS 14489:2018
 - NDT Witness – UT,MPT,RT,LPT
 - Third Party Inspection
 - Thickness mapping of Pipe Line, Vessel, Tank
 - Noise Level and Illumination Level Measurements
 - IMS Co ordination

Address : 621, Unity Plus, Opposite Suvarna Bhumi Complex,
Nana Mova Main Road, Behind Speedwell Party Plot, Rajkot - 360005
Email : mqis.rajkot@gmail.com Mobile No. : 94279 64701 | 90818 85344



Centrifugal Mono-block Pump,

Open-well Pumps,

V4/V6 Submersible Pump-sets,

Self Priming Pumps &

Electric Motors.

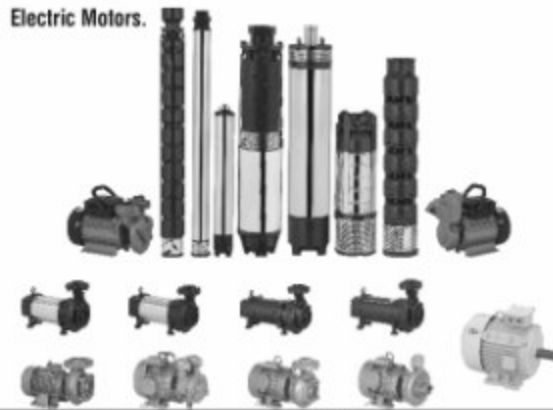

Plot No. 150, Dindayal Ind. Estate, Opp. Gamara Hotel,
N.H.8-B, Aji Vasahat, Rajkot-360 003.
Cell : +91 97277 33357, +91 97277 33358
Email: loyalpump@gmail.com Visit us: www.loyalpump.com



RK[®]
AUTO SPARES



SHALIMAR
Engineering Works

Manu. : All Type of Engine Auto Valve

6, Atika Ind. Area, Dhebar Road (South),
Nr. Khodiyar Garage, Rajkot-360002
Mobile : 9879991005
Email : shalimaraautospare@gmail.com

Arun[®]
PUMP

Smart and Reliable
Solar-Powered
Pumping Solutions



AMAL PUMP LLP
Mfg. Submersible Pump & Openwell
Plot no. 204, D.S. No. 438, Nr. Dhebar, Madhavindia, Dist. Rajkot, Gujarat, India. Phone: 9879991005

Hardik Patel
+91 74055 73555

info@amalpump.com
www.arunpump.com

Jay Chirag[®]
SUBMERSIBLE PUMP SET

MADE IN INDIA

V-3, V-4, V-5, V6,
Submersible &
Openwell Pump Set



Mfg. By:

Chirag
Industries

Jay Swarn Industrial Estate,
NH-58, Nr. Meera Udyog,
Rajkot - 360003 (Gujarat) India.
+91 281 2384038
info@chiragpumps.com
www.chiragpumps.com



GREENSTONE

A Next Generation Product
Green Building Solution

Fly-Ash Bricks
Plant



Low Investment
Quick Returns



Light Weight Blocks Made Easy
CLC Plant



Paver Block Plant
CLC Block Plant
Precast wall Plant
Precast Mold
Pre-Mix mortar plant
All kind of Mixer



HEM CARE CORPORATION

Manufacturers & Exporters all kind of Eng. Goods.

Off./Fac.: G/1505, G.I.D.C., Opp. Telephone Exchange, At. Metoda, Ta. Lোধિકા, Rajkot (Guj.) INDIA
Phone: +91 94269 96888, 094262 01058 E-mail: hemcare@gmail.com

www.hemcarecorporation.com



રાજકોટ એન્જીનીયરીંગ એસોસીએશન ઓડીટોરીયમ હોલ વપરાશ ચાર્જ્સ બેઠક વ્યવસ્થા ૩૩૦ વ્યક્તિ

ક્રમ	વિગત	૩ કલાક માટે (સ્તેબ-૧)	૬ કલાક માટે (સ્તેબ-૨)	૯ કલાક માટે (સ્તેબ-૩)
૧.	ઓડીટોરીયમ હોલ ભાડુ	રૂ. ૭,૦૦૦/-	રૂ. ૧૧,૦૦૦/-	રૂ. ૧૩,૫૦૦/-
૨.	સફાઈ તથા મેઈન્ટેનન્સ	રૂ. ૧,૩૦૦/-	રૂ. ૧,૩૦૦/-	રૂ. ૧,૩૦૦/-
૩.	માઈક ઓપરેટીંગ ચાર્જ	રૂ. ૨૨૫/-	રૂ. ૩૫૦/-	રૂ. ૪૦૦/-
૪.	કોર્ડ લેસ માઈક વપરાશ ચાર્જ	રૂ. ૧૦૦/-	રૂ. ૧૫૦/-	રૂ. ૨૦૦/-
૫.	કોલર માઈક વપરાશ ચાર્જ	રૂ. ૧૦૦/-	રૂ. ૧૫૦/-	રૂ. ૨૦૦/-
૬.	LCD પ્રોજેક્ટર/સ્ક્રીન 7x6 LCD TV	રૂ. ૧,૦૦૦/- ૨,૦૦૦/-	રૂ. ૧,૫૦૦/- ૩,૦૦૦/-	રૂ. ૨,૦૦૦/- ૫,૦૦૦/-
૭.	જનરેટર ચાર્જ પ્રતિ કલાક	રૂ. ૩,૦૦૦/-	રૂ. ૩,૦૦૦/-	રૂ. ૩,૦૦૦/-
૮.	ઇલેક્ટ્રીક વપરાશ ચાર્જ પ્રતિ યુનિટ	રૂ. ૧૮.૦૦/-	રૂ. ૧૮.૦૦/-	રૂ. ૧૮.૦૦/-
૯.	GST	રૂ. ૧૮.૦૦%	રૂ. ૧૮.૦૦%	રૂ. ૧૮.૦૦%
૧૦.	બુકીંગ સમયે ડીપોઝીટ	રૂ. ૨૦,૦૦૦/-	રૂ. ૨૫,૦૦૦/-	રૂ. ૩૦,૦૦૦/-

રાજકોટ એન્જીનીયરીંગ એસોસીએશન બોર્ડરૂમ/કોન્ફરન્સરૂમ વપરાશ ચાર્જ્સ બેઠક વ્યવસ્થા ૫૦ વ્યક્તિ

ક્રમ	વિગત	૩ કલાક માટે (સ્તેબ-૧)	૬ કલાક માટે (સ્તેબ-૨)	૯ કલાક માટે (સ્તેબ-૩)
૧.	બોર્ડરૂમ ભાડુ /કોન્ફરન્સ રૂમ	રૂ. ૩,૦૦૦/-	રૂ. ૪,૨૦૦/-	રૂ. ૫,૨૦૦/-
૨.	સફાઈ તથા મેઈન્ટેનન્સ	રૂ. ૨૭૫/-	રૂ. ૪૦૦/-	રૂ. ૪૦૦/-
૩.	માઈક ઓપરેટીંગ ચાર્જ	રૂ. ૧૨૫/-	રૂ. ૧૭૫/-	રૂ. ૨૨૫/-
૪.	કોર્ડ લેસ માઈક વપરાશ ચાર્જ	રૂ. ૧૦૦/-	રૂ. ૧૫૦/-	રૂ. ૨૦૦/-
૫.	કોલર માઈક વપરાશ ચાર્જ	રૂ. ૧૦૦/-	રૂ. ૧૫૦/-	રૂ. ૨૦૦/-
૬.	LCD પ્રોજેક્ટર	રૂ. ૧,૦૦૦/-	રૂ. ૧,૫૦૦/-	રૂ. ૨,૦૦૦/-
૭.	જનરેટર ચાર્જ પ્રતિ કલાક	રૂ. ૩,૦૦૦/-	રૂ. ૩,૦૦૦/-	રૂ. ૩,૦૦૦/-
૮.	ઇલેક્ટ્રીક વપરાશ ચાર્જ A.C.	રૂ. ૫૦૦/-	રૂ. ૭૦૦/-	રૂ. ૧,૦૦૦/-
૯.	GST	રૂ. ૧૮.૦૦%	રૂ. ૧૮.૦૦%	રૂ. ૧૮.૦૦%
૧૦.	બુકીંગ સમયે ડીપોઝીટ	રૂ. ૮,૦૦૦/-	રૂ. ૧૦,૦૦૦/-	રૂ. ૧૩,૦૦૦/-

wef. 01-05-2023

નોંધ : (૧) ઓડીટોરીયમ હોલ/બોર્ડરૂમ/કોન્ફરન્સરૂમ જેટલા સમય માટે બુકીંગ કરાવેલ હોય તે સમય પહેલા અર્ધા કલાકે ખોલી

સોંપવામાં આવશે તેની ખાસ નોંધ લેવા વિનંતી. તદ્ઉપરાંત બુકીંગ કરાવેલ નિર્ધારિત સમયે તે પહેલાં, પાંચ મીનીટ અગાઉ કાર્યક્રમ પુરો કરી, ઓડીટોરીયમ હોલ/બોર્ડરૂમ/કોન્ફરન્સ રૂમ પરત સોંપવાનો રહેશે. જો આમ છતાં બુકીંગના નિર્ધારિત સમયથી કાર્યક્રમ વધુ ચાલશે તો તે પછીના સ્તેબનો ચાર્જ વસુલ કરવામાં આવશે.

(૨) લંચની પરમીશન મળેલ હોય તો કેટરીંગ વિગેરેની વ્યવસ્થા આગલા દિવસે રાત્રે ૮.૦૦ વાગ્યા સુધીમાં કરવી અને

ડીનર માટે બપોરે ૩.૩૦ વાગ્યા પછીથી વ્યવસ્થા કરવાની રહેશે જેની ખાસ નોંધ લેવા વિનંતી.

(૩) પોર્ચ ઉપયોગનો ચાર્જ લંચ/ડીનર રૂ. ૧૫૦૦/-, હાઈ-ટી રૂ. ૧૦૦૦/- તેમજ ટી-કોફી ના રૂ. ૫૦૦/- અલગથી આપવાના રહેશે.

PAYMENT : RAJKOT ENGINEERING ASSOCIATION

BANK : BANK OF INDIA, SME BHAKTINAGAR BRANCH, RAJKOT.

A/C. No. : 312120110000222 IFC CODE : BKID0003121



C I rotors



C I rotors and drums



Cast iron engine



Cast iron drums



Ductile iron pipes



Cast iron 5-25 kgs



Cast iron 25-70 kgs



Cast iron broken Machinery



Cast iron chips



M S profile cutting scrap



M S plate cutting scrap



M S fish cutting scrap



M S angle cutting scrap



Busheling scrap



CRC busheling bales



Seamless & welded pipes



Alloy Steel Scrap



Secondary M S plates



FINE TRADE LINK

CAST IRON SCRAP | MS SCRAP | MS PIPES | PROFILE PLATES | PRIME PLATES

📍 10th Floor, Office No.10, Victoria Bliss, Opp. Victoria Park, Iscon Mega City, Bhavnagar-364001 (Gujarat) India

☎ +91-8141 464 646 / +91-9979 140 000 📞 +91-278-2421414 / 2421412

✉ info@finetradelink.com 📧 finetradelink@yahoo.com 🌐 www.finetradelink.com



RAJKOT ENGINEERING ASSOCIATION

REANA સભ્યોની સવલત અંગેની ઉપલબ્ધતાઓ

૧. એક્સપોર્ટર માટે સર્ટીફિકેટ ઓફ ઓરીજીન ચાર્જ રૂ. ૧૩૦/- પ્રતિ સર્ટીફિકેટની સવલત.
૨. ઓડિટરીયમની સવલતો
 - A.C. કોન્ફરન્સ રૂમ ૫૦ ની બેઠક સાથે.
 - A.C. બોર્ડ રૂમ ૫૦ ની બેઠક સાથે.
 - A.C. ઓડિટરીયમ ૩૩૦ ની બેઠક સાથે.
 - LED TV / અલ્ટ્રા મોર્ડન સાઉન્ડ સીસ્ટમ, મોટોરાઈઝ્ડ સ્ક્રીન, પ્રોજેક્ટર તથા લેપટોપ સાથેની સવલત.
૩. વિડીયો કોન્ફરન્સીંગ ફેસેલીટી જેમાં ૨૫ સીટીંગ કેપેસિટીની સવલત.
૪. લાયબ્રેરી : ટેકનિકલ, નોન ટેકનિકલ બુક્સ સાથેની અધતન સુવિધા સાથેની લાયબ્રેરી.

ભક્તિનગર ઈન્ડ. એસ્ટેટ જી.આ.ડી.સી.,
શેરી નં.-૩, રાજકોટ.
Mo. 99132 14935 / Email : info@reaindia.com





Manufactures :
CNC, PLC Hydraulic, Internal, External & SPM
Grinding Machine,
For Production & Tool Room



CNC Cylindrical Grinding Machine
2000 mm



Cylindrical Grinding Machine
150 x 300 mm

શ્રી BUTBHAVANI
MECHANIC WORKS

J.P. Marg, Street No. 1 Dudhrej Road, Surendranagar - 363 001. Gujarat, India.
Mobile : 09925004333, 09825223885 | Email : bmwswasticgrinders@gmail.com
www.swasticgrinders.com



An ISO 9001:2015 Company



- 40 | Feet Head Per Stage in V-5 Pump
- 45 | Feet Head Per Stage in V-6 Pump
- 50 | Feet Head Per Stage in V-6 Pump
- 70 | Feet Head Per Stage in V-6 Pump
- CED | Coating On All Casting Parts

Mfg.: V-3, V-4, V-5, V-6 & Openwell
Submersible Pumps

Manufactured By:
ACTIVA PUMPS

Somnath Ind. Area, In Side Kothariya Railway Crossing, Opp. Krishana Park
Hotel, Gondal Highway, Rajkot. (Guj.) Mo. +91 98257 23323
✉ activapumps@gmail.com 🌐 www.activapumps.in



SINCE 1963

Fieldmarshal

Marshalling Green Fields

MILLIONS OF SATISFIED CUSTOMERS WORLDWIDE



FMA 12 and FMW 14 Engines

PMT 15 and PMT 18 Engines

Bore well Submersible Pumps

CPVC, UPVC, SWR and AGR1 Pipes & Fittings

Lister Engines

High Speed Diesel Engines and Pump Sets



Mini Manoblock Pumps



SS Open well Submersible Pumps



Induction Motor



Centrifugal Manoblock Pumps



Alternators



CI Body Open Well Submersible Pumps



Mini Manoblock Pumps



P. M. DIESELS PVT. LTD. , ARVIND INDUSTRIES P.O. BOX NO. 1003, AJI INDUSTRIAL ESTATE, RAJKOT - 360003 (GUJRAT - INDIA) Phone: +91-9106882861 Fax: +91-9023550564 Email: contactus@fieldmarshal.com



Discover THE WORLD WITH US



Unlock Exclusive Our Services

- ✦ FLIGHT BOOKING
- ✦ CRUISE BOOKING
- ✦ HOTEL BOOKING
- ✦ DOMESTIC & INTERNATIONAL TOUR PACKAGES
- ✦ MICE & CORPORATE TOURS
- ✦ CHARTER FLIGHT BOOKING
- ✦ EURO RAIL BOOKING
- ✦ PASSPORT ASSISTANCE
- ✦ USA & CANADA PASSPORT RENEWAL
- ✦ VISA SERVICE
- ✦ CANADA PR PROCESS
- ✦ ATTESTATION / APOSTILLE SERVICE
- ✦ TRANSLATION SERVICE



ASSOCIATE WITH



102 - Balaji Square, Sarveshwar Chowk,
Yagnik Road, Rajkot - 360001

099240 77731 / 099248 77731

www.royalfoursntravels.com
royalfoursntravels@gmail.com



SHAPET INDUCTION PVT. LTD.

Our Machines, Ranging From 40KW To 100KW, Are Engineered To Meet The Demands Of Modern Industry, Offering Unmatched Precision, Reliability, And Efficiency

SPECIAL APPLICATION OF OUR PRODUCT



STRIP HEATING



INDUCTION BRAZING



SHRINK FITTING



INDUCTION HEATING

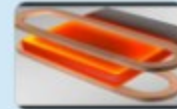

INDUCTION ANNEALING



WWW.SHAPET.IN

SHAPET INDUCTION PVT. LTD.

Gate No. 1, Plot No.-2605/A, Rd Number 11, GIDC Metoda, Near Silver Techno cast, Metoda-360021. Gujarat (India)

+91 98794 61162 / +91 98253 69897

Sale@shapet.com

OUR PRESENT IN ABROAD

- UAE (Dubai)
- USA
- MALAYSIA
- SINGAPORE
- AUSTRALIA
- BANGLADESH
- ITALY
- NEPAL
- OMAN
- SAUDI ARABIA
- TANZANIA
- SRI LANKA

REVOLUTIONIZING GRINDING SOLUTIONS

KIYA



EG Series
CNC External Cylindrical Grinders

HCG Series
Hydraulic Cylindrical Grinders

CL 100
Hydraulic Centerless Grinder

IG 30
CNC Internal Cylindrical Grinder

GRINDING SOLUTIONS

- CNC External Cylindrical & Track Grinder
- CNC Internal Cylindrical & Track Grinder
- CNC Centerless Plunge Grinder
- CNC LIP Grinder
- Horizontal Spindle Rotary Table Surface Grinder
- External Cylindrical Grinder
- Internal Cylindrical Grinder
- Centerless Grinder
- Special Purpose Grinder

ABOUT US

KIYA PRODUCTS PRIVATE LIMITED is a rajkot based manufacturer of precision grinding machines under the brand name "KIYA" with a legacy of more than 3 decades of its heritage. To accommodate our growing business "Ignite Inc" formerly known as Champkraft Machine Tools under the brand name "Solco Grinders" with a legacy of over 35+ years in grinding machines is now moved to Rajkot with a better infrastructure, quality, and a new range of grinding machines. Kiya portrays its extensive expertise in manufacturing various grinding machines meeting the customer's prospects and expectations in terms of quality, precision, productivity & reliability.

KIYA

Kiya Products Private Limited

Plot No. G-1925, Gate-2 (Almighty Gate), Kalawad Road,
Lodhika GIDC, Vill.- Metoda, Dist.- Rajkot 360 021, Gujarat, India.
E info@kiyaproducts.com M +91 99789 61509

Sales | sales@kiyaproducts.com, +91 93281 61506,
Service | service@kiyaproducts.com, +91 99781 61507

kiyaproducts.com

Fly Your Dreams...
BEST[®]

TOURS & FOREX Pvt. Ltd.

SINCE: 1996

ગુજરાતી મહારાજ સાથે યુરોપ ટુર સૌરાષ્ટ્ર માં સર્વ પ્રથમ



Rajkot



+91 80005 00050

Ahmedabad



+91 81005 00050

Sagar Parsana
+91 98795 86565

Bansi Parsana
+91 96876 10910



**Mfgr. of all kinds of Precision Graded
C.I. Casting. Ranges from 1 kg. to 15 Ton**

📍 2-Sanskar Society, Near Khokhad Dadi River,
National Highway-27, Rajkot - 360 002.

✉ info.krunalmanu@gmail.com

Shailesh
SINCE : 1970

TWO COLUMN WIDE BED PRESS

HYDRAULIC SHEARING MACHINE
HYDRAULIC PRESSBRAKE MACHINE
TYPE HIGH SPEED PRESS MACHINE
C" TYPE POWER PRESS MACHINE

MANUFACTURED & EXPORTED BY
SHAILESH GROUP OF COMPANIES

SCM Shailesh KSP View Devdani

2/10 (NEW 20), Shaktinagar Station Plot Rajkot - 360 030, Gujarat - India
E-mail : info@shaileshmachines.com | info@shaileshmachines.com & www.ksppress.com

DIPESH
Since 1979

MANUFACTURE OF
HYDRAULIC
THREAD ROLLING MACHINE.

Golden Client

PERFECT RESEARCH
FINE THREAD FORM INDUSTRIES

Hydraulic Thread Rolling Machine Model G1 25mm
Hydraulic Thread Rolling Machine Model G1 40mm

Plot No. G-2052/A, Near Shree Ram Hospital, Klahan Gate, Kalawad Road, Metoda GIDC, Rajkot (Gujarat - India).
Ph. 02827 - 288032, Mo. 99799 09032 / 99138 55204 / 73631 62032
E-mail : info@dipeshindustries.in | dipeshmakwana5@gmail.com
Web : www.dipeshindustries.in

SCM SHREE CHAMUNDA METALS

Our Expertise

Tractor Sheet Metal Parts.
Rotavator Sheet Metal Parts.
All Type Of Sheet Metal Works.
Deep Draw Works.

SHREE CHAMUNDA METALS

Address : 149/A Meera Udhog, Street no. 8, Nr. Banshidhar Weigh Bridge, Aji Vasahat, Rajkot - 360003.
Call : 90333 38040 | 90993 78497

ONE STOP SHOWROOM FOR HOSPITAL & HEALTHCARE PRODUCTS.

AN ISO 9001 : 2008 & ISO 13485 : 2015 AC 2012, CE, FDA & GMP CERTIFIED COMPANY

WESTERN SURGICAL EQUIPMENTS PRIVATE LIMITED

We are Available on : GeM

OUR CORPORATE OFFICE

"Happy Home", 1st Floor, 23, Karampara, B/H. S.T. Bus Stand, Kanak Road, Rajkot-360 001. Ph. : +91 281-2222871/2243159
Mo. : +91 98250 69060 - +91 98250 45967
Email : westernsurgical@gmail.com
www.westernsurgical.in

OUR MANUFACTURING UNIT

7-Dhwani Industrial Estate, Nr. Kothariya Railway Crossing, B/H. Jay Ganesh Ford Service Center, NH-4B, Gondal Road, Nr. Meera Papadi, Rajkot-360 007, Gujarat (India).
M. : +91-94288 03751



DRILLS, ENDMILLS, REAMERS, THREADMILLS & CUSTOMIZED TOOLS

Manufacturing & Re Conditioning
of Solid Carbide Round Tools

OPPORTUNITY FOR SOLID CARBIDE TOOLS!



MANUFACTURER OF SOLID CARBIDE TOOLS

59 - A, Maruti Industrial Estate, B/h. Ashish Engineering Works, Outside,
Octroi Post, Gondal Road, Rajkot - 360004, Gujarat (INDIA).

info@smoothtools.in | www.smoothtools.in | +91 99131 01111, +91 99786 99789

Follow Us On :



Nailless Plywood Box
Plywood Pallet
Pinewood Pallet
Pinewood Box

Nailless Box are
Manufactured with
German Technology.

JAGTAT WOOD PACKSAFE

Plot No.-1 & 2/3, Survey No. 289,
Vill. New Haripar (Taravada), Tal. Lodhika,
Dist. Rajkot - 360 004. Gujarat, India.
+91-99250 19190 | +91-94088 61715
jagtat.wps@gmail.com | www.jagtatnaillessbox.com



JAGTAT
we protect your product



Jagdish®

Submersible Pumps

Since 1985



JAGDISH ENGINEERING INDUSTRIES
 RAJKOT (GUJARAT)
 MOBILE : 70418 87873 / 70418 87879

Addison®

The Safe Connection
 ELECTRIC WIRES & CABLES



PRODUCT RANGE :-

- FR & FR-LSH House Wires
- Submersible Flat Cables
- Industrial Cables
- Multi core Flexible Cables
- Aluminium Cables
- LT Power And Control Cables



AN ISO 9001 : 2015 Company



Mfg. By:
ADDISON CABLE PVT. LTD.
 Plot No. P - 8/9, Road No. B, Opp. V-Trans, Kalavad Road,
 G.I.D.C. Lodhika, AT - METODA - 360 021, Dist. Rajkot (Guj.) INDIA.
 Ph: +91-2827-287475/297475 Mo. :- +91 98252 81182
 E: info@addisoncables.com W: www.addisoncables.com

Mfgd. By:
ADDISON INDUSTRIES
 B/H. Welder Enterprise, Aaka Street No. 11,
 Dhebar Road(South), Rajkot - 360002
 Mo. :- +91 99135 15253
 Ph. :- +91 281 236537 / 2361595



MINIMATIC®
 MOST TRUSTED NAME IN SPM

CNC Turning Center



Sliding Head CNC
 (SLD-10 & SLD-20)



CNC Turning Center
 (MGT-75)



MINIMATIC MACHINES

Plot No. G-2017, Road L-1, GIDC Lodhika, Almighty Gate, VII, Metoda, Dist. Rajkot - 360021.
 Mob. 953721134 | Email: sales@minimaticmachines.com
 URL: www.minimaticmachines.com | www.indiamart.com/minimatic-machines

SUPER SLIDE

**BALL SCREW,
 LM GUIDEWAYS
 & CNC ACCESSORIES**



PMI
 BALLSCREWS



PMI
 LINEAR GUIDEWAYS

YNSH
 PRECISION LOCK NUTS



Flexible couplings for Servo Motors



Ballscrew Support Units

MACHINING SYSTEMS

Veer Narmad Township Shop No.-4, Samrat Indl. Area Main Road,
 B/H S.T. Workshop, Gondal Road, Rajkot - 360 004. (Guj.)

Contact No. : 097123 59021

E-mail : ballscrew.rajkot@gmail.com

www.superslides.in

AirTract

Total Solution for Air & Pneumatic Equipment



SINCE 1997



CE AN ISO 9001-2015 COMPANY



MFG. BY:
RAJAN MACHINES (INDIA) PVT. LTD.

AKAR ESTATE, 1ST FLOOR, 3-ATIKA INDUSTRIAL AREA, DHEBAR ROAD (SOUTH), RAJKOT 360 002. (INDIA)
+91 96019 38051, 9081839200, 9081839300
rajanmachinesindia@gmail.com www.rajdhaniaircompressor.com



An ISO 9001:2015 Company



Century®

સેન્ટ્યુરી®



WIDE RANGE IN COOLANT PUMP



CENTURY AGRO ENGINEERS

2-Umakant Udhyognagar, Mavdi Plot, RAJKOT - 360 004.

Cell No.: 78020 06464 E-mail : ameerrajkot@yahoo.com, Visit us: www.ameerrajkot.com

Manufacturer of EOT Crane & Material Handling Equipments

TOP CRANE®

Maximizing The Human Efficiency



DOUBLE GIRDER EOT CRANE



GOLIATH CRANE



SINGLE GIRDER EOT



JIB CRANE



WIRE ROPE CRAB



WIRE ROPE HOIST



END CARRIAGE



MATERIAL HANDLING SOLUTION

TOP CRANE SYSTEM PVT.LTD.

Maximizing The Human Efficiency

Email : sales@topcrane.in / inquiry@topcrane.in
Website : www.topcrane.in

Mo. : +91 6354 011 480 | +91 97129 77753

Mfg. : All Kinds Of Gunmetal & Phosphorus Bronze Metal Bushes, Split Brass, Gears And Non Ferrous Casting From 10gms To 250kgs As A Single PC Of Precision Components.



ISO 9001 : 2015

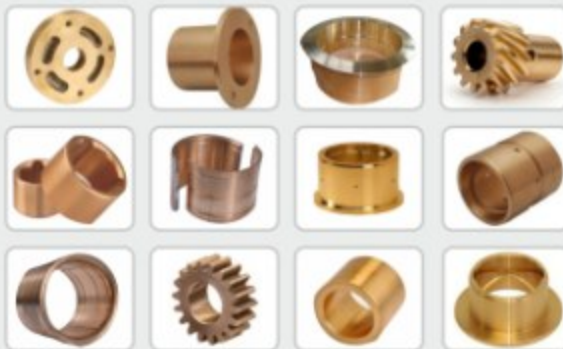

SAURASHTRA BRASS INDUSTRIES LLP

"METAL HOUSE", NR. ANDH MAHILA VIKAS GRUH, DHEBAR ROAD, RAJKOT - 360 002 (GUJARAT). INDIA

EMAIL : saurashtrabrass@gmail.com, info@saurashtrabrass.com

WEB : www.saurashtrabrass.com

Mob. : +91 97277 55993, +91 99250 01445

MR. DARSHIT PATEL, MR. PRATIK PATEL



RAJKOT ENGINEERING ASSOCIATION



18th Edition

**Directory & Bulletin Project
2024 - 2025**

**BOOK YOUR
ADVERTISEMENT**

Marketing & Project by
**GUJARAT
Ad & Media**

**93333 93375
90337 99367**



Fashion redefined, for men of distinction.
Impeccable craftsmanship weaves Italian grace. A versatile range of pure wool fabrics handpicked from the heart of Italy where fashion meets everlasting elegance.

REGIO ITALIA
ITALIAN FASHION HOUSE

Available at
THE Raymond SHOP



RAJKOT: Scan For Location



MORBI: Scan For Location

**RAJKOT: Nakshatra-2, 150 Ft. Ring Road, Nr. KKV Circle ☎ 9106520773
MORBI: Ram Chowk, Savsar Plot Main Road ☎ 7016086599**

ATUL MACHINE TOOLS
Quality is a Matter of Trust





CNC External Grinding Machine
Size : 600 mm & 1000 mm



Hydraulic & Mechanical Cylindrical Grinding Machine
Size : 400 mm to 1300 mm



Hydraulic & Manual Surface Grinding Machine
Size : 600 x 300 mm, 450 x 225 mm

Website : www.atulmachine.com

Almighty Gate, Plot No. P-103, Lodhika G.I.D.C, Kalawad Road, Metoda, Rajkot, Gujarat-360021, India.
Office: +91-2827-297607 | Mob. : +91-8758466424 | Email : sales.atulmachinetools@gmail.com

Manufacturer & Importer of :
All Kind of Fasteners

माँ



S. N. Enterprise

📍 "Shree Shakti", Godown Road, 14-Bhaktinagar Station Plot, Nr. Pashu Dawakhana, Rajkot - 360 002.
☎ 90161 03404 📞 97266 03404
✉ nemish@sngroups.in 🌐 www.sngroups.in

**VIKRAM**www.vikramvalves.com

IATF 16949:2016, ISO 14001:2015, ISO 45001:2018
Certified Company



A Global Supplier of **Engine Valves**

Serving a Diverse, Global Customer Base for more than 45 years

AVR (Vikram) Valves is one the most reliable and trusted source for **High Quality Engine Valves & Valve Train Components** for a wide array of Industries, including Tier-1 and Tier-2 Automotive Manufacturers. 'Vikram' is now a Globally recognized Brand and Company is matching the footsteps of Globalization by exporting to **USA, UK, Germany, China, South Korea** and almost all over the World.



AVR (Vikram) Valves Pvt. Ltd.

Plot No. 2317-2318, G.I.D.C Lodhika Industrial Estate, Almighty Gate No. 2, Rajkot - 360 021, (Gujarat) India.

T: +91 2827 287358 | 287359 E: info@vikramvalves.com W: www.vikramvalves.com

Kiran INDUSTRIES

K+



ANCHORING YOUR SUCCESS EVERY STEP OF THE WAY



ALLEN CAP BOLTS
HIGH TENSILE HEX BOLTS
HIGH TENSILE HEX NUT

HEX BOLTS & HEX NUT
FLANGE NUT
HEX WELD NUT

COPPER BOLT & NUT
BRASS BOLT & NUT
CUSTOM FASTENERS



RAJ BHALANI
+91 98245-98000

KETAN BHALANI
+91 99045-98000

kiran.fastners@yahoo.com
Sr. No. 211, Plot No. 3, Essan Road,
At Veraval- Shapar, Tal. Kotda Sangani,
Dist. Rajkot - 360 024. (Gujarat) INDIA.

MANUFACTURER OF ALL TYPE OF ENGINE VALVE



G-409/410, Opp. Decora Bhavan, G.I.D.C. Metoda, Kalawad Road,
Rajkot - 360021 (INDIA) | Telefax : +91-2827-287285, 287385
Email : unicornvalves@yahoo.co.in | Website : www.unicornvalves.com



Mfg. : Mild Steel, Stainless Steel, Manganese Steel,
Marine Anchor & Alloy Castings
Capacity : Single Pic - 5 Kg to 4000 Kg.



Poonam Metals

Metoda GIDC, Plot No. G-1330, Opp. Kishan Auto, Kishan Gate, Klawad Road,
Dist. Rajkot - 360021, Gujarat (INDIA) Mo. : +91 99981 13603, +91 97149 99905
E-mail : poonammetals1330@gmail.com Web. : www.poonammetals.co.in



OM METAL CAST

SHAPING THE FUTURE

AN ISO 9001:2015 CERTIFIED COMPANY



Manufactures of Grey & SG Iron Castings.

Product Range:

- ELECTRIC MOTOR STATOR HOUSING & PARTS
- MOTOR STATOR & SHIELD COVERS
- SUBMERSIBLE PUMP CASTING PARTS
- BEARING COVERS & BEARING HOUSING
- OTHER GRADED GREY & SG IRON CASTING

Office & Work :

Survey No. 280/1, Opp. Prince Villa, Kuvadva-Wankaner Road, NH-27, Village : Jhiyana. POST: Jhiyana. Dist. Rajkot - 360023. (Gujarat)

info@ommetailcast.com www.ommetailcast.com

Sunilbhai Patel
+91 94262 16320

Milan Patel
+91 92277 60040

Sterling®

SUBMERSIBLE PUMPS



CELEBRATING
25 YEARS
OF EXCELLENCE
1997-2022

A Wide Range of Quality Pump Sets



The Most Rugged, Trouble Free & Economical Pump Set.



SIDDHI ENGINEERS

Mfg.: SUBMERSIBLE PUMPSETS

G-2223, Kraml Gate Main Road, Ladhika G.I.D.C., Al. METODA, Dist. Rajkot - 360 021 (Gujarat) INDIA.
Phone : +91 2827 267168 • Mo. : +91 70465 00065 • E-mail: info@sterlingpumps.in • Web: www.sterlingpumps.in

Mfg. of : 0.5 HP to 10 HP SINGLE & THREE PHASE INDUCTION MOTOR



Mfg. of : ALL SUBMERSIBLE CASTING KIT



BEM Jay Bajarang Electric Manufacture

Laxminnagar Main Road, 6-Mahadev Wadi, B/h. Haveli, Mavdi Plot, Rajkot - 360 004
E-mail : jaybajarangeleandmanufacture@gmail.com
Ph. : 0281-2371667, Cell : +91 98256 72592



ALL KINDS OF C.I. CASTING MANUFACTURERS



Murlidhar® TECHNOCAST

Gondal Road High-way, B/h. Parin Furniture, Rani Industrial Area, Survey No. 17, Vavdi-Rajkot, Vallabhbhai Patel 98250 94924



Web : www.murlidhartechnocast.com • Email : murlidhartechnocast@gmail.com

Rashmi Patel

B.E. (Mech), PGDFM
Mo. : +91 98257 09220

Nishant Patel

B.E. (Mech), MBA
Mo. : +91 94295 79366

Mfg. of Bearing Lock Nuts,
Adapter Sleeves,
Lock Washer, Precision Lock,
Nuts and Hook Spanners

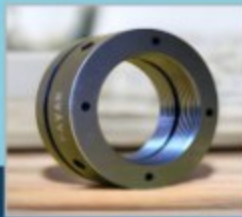

2, Gokulnagar, Nr. Nirav Commercial Complex,
Gokuldham Main Road, Rajkot - 360 004
Ph.: 0281 - 2312005,
Email : rppatel.pavan@gmail.com

www.stampingsindia.com



QUALITY
The Right
Choice.

We are **Unique** in
Quality Products...



Call us now... **098250 76967**

Manu. : All kind of Electrical Stampings & Laminations

Plot No. G-1882-83, M-Road, Kishan Gate, (Gate No. 3)
Nr. Shree Ram Hospital, Lodhika G.I.D.C., Dist Rajkot, At Metoda.

☎ : +91 - 2827 - 287513
☎ : +91 98250 76967

✉ : info@stampingsindia.com
🌐 : www.stampingsindia.com



Engines - Diesel



Spare Part of Engine



Pump & Mud Pump



Oil / Pipe



Manufacturer & Exporter (An ISO 9001-2015 Certified Company)
GUJARAT FORGINGS PVT. LTD.
 Opp. N.S.I.C., 80 Feet Road, Aji Industrial Area, Rajkot - 360 003 (India).
 Email: info@fieldmarshalengine.com | Customer Care No. +91 99740 56831/32/34
 Web: www.speedwel.com | Follow us: [f](#) [t](#) [i](#) [c](#) [o](#) [o](#) [o](#) @Speedwel | [t](#) [o](#) [o](#) +91 99740 56831

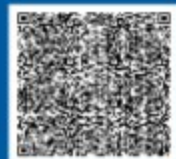



WORLD CLASS TESTING AUTOMATION FOR ALL KIND OF PUMP & MOTOR WITH IN-HOUSE NABL LABORATORY



WORLD'S
1st



INDUSTRIES
SERVED



Fully Automatic
(NO Load)
Routine Test Panel

Smart Power Analyzer
with
Pump and Motor
Evaluation parameter

Electromagnetic
Flowmeter

More than
5000+
Customers world-wide

More than
200+
Standard Products

More than
100000+
Installation world-wide

AAROH EMBEDDED SYSTEMS PVT. LTD.

THE COMPANY FOUNDED BY ALUMNUS OF IIT, BOMBAY



Plot No. G-(1004-8)A, Kishan Gate No-3 Main road, Nr. Durga Weigh Bridge, GIDC Metoda, Village Lodhika, Kalawad Road, Rajkot, Gujarat (India.) - 360021.

+91-02827 297280

+91 95129 99942



www.aarohies.com

Email: Info@aarohies.com



NIKOO

TECHNOCAST
"Casting Metal to Life"

"Mfg Of Ductile Iron, Cast Iron & Precision Machined Components."

ONE STOP SOLUTION FOR ALL YOUR CASTING REQUIREMENTS

We Believe In Cultivating Lifelong Relationships. We Welcome You To Join Nikoo Family.



+91 74059 87299

www.nikootechnocast.com

Info@nikootechnocast.com

Veraval (Shapar), Rajkot



The single window to every logistics solution you need

From transportation solutions for different kinds and sizes of cargo, to anywhere-in-India reach and warehousing services and more... V-Trans has it all and is therefore the partner of choice for countless businesses in diverse sectors.



DIFFERENT ARMS,
MANY POSSIBILITIES:



Solutions: Surface transportation, Time-bound express cargo, Warehousing and inventory management, Integrated supply chain



V-Trans (India) Limited Head Office: Unit 06, Corporate Park, V N Purav Marg, Chembur, Mumbai - 400 071.
 ☎ 9870140141 | ✉ info@vtransgroup.com | 🌐 www.vtransgroup.com
 To know more, call us on 9376 888 837 | Email: jignesh@vtransgroup.com

QR Code of Phone App QR Code of Website

We Believe in Quality

TEZZ® Air Compressor

Double & Single Cylinder Air Compressor

Manu. & Mrkt. : Air Compressor, Sprayer Pump, Cut off Machine, Electric Air Blower, Electric Motor & Jigsaw Machine.

SHIV SHAKTI ENTERPRISE
 Survey No. 32, Plot No. 6, Opp. Poonam Dumper, Street of Perfect Tata Show Room,
 Rajkot Gondal Highway, Vard, Rajkot-360004 (Gujarat)
 Mo. : 9426996444, 9979277540, 9723871960 E-mail : info@tezzaircompressor.in

Page No. 2023

Filltop®

एक कदम....
समृद्धि की ओर....

SUBMERSIBLE PUMPS

IS-14200
CML-780003418

IS-10004
CML-7810070

IS-10004
CML-7810070

IS-10004
CML-7810070

IS-10004
CML-7810070

IS-10004
CML-7810070

IS-10004
CML-7810070

IS-10004
CML-7810070

IS-10004
CML-7810070

Manu. By : **B.M. ENTERPRISE**
 Ankit Industrial Estate, Plot No. 11, Opp. Krishna Park
 Railway Crossing, Gondal Road, (Kothariya) Rajkot. (Guj.) INDIA
 Customer Care No. : 88 66 74 20 62



15 kg to 1000kg
Green Sand and No back Process

CI & SG Iron Casting - as per Your Pattern.

Accord Inducto Cast

Quick Contact 'ACCORD', Plot NO.5,
Survey No.45, Nr. Bharat Nagar,
Vavdi, Rajkot - 360004,
Gujarat - INDIA.



Valve and Pump Castings



Gear & Transmission Parts

Mr. Ketan Gajera

- +91 99988 44445
- sales@accordcasting.com
- www.accordcasting.com



Machinery Castings

Excellent Attitude &
Performance Lead to Quality



AN ISO 9001 : 2015 COMPANY



THE **100%** PERFECT CHOICE FOR
YOUR WORKSHOP



Mechanic's Bench Vices
(With Fixed or Swivel Base
Oxford Blue Color)



Mechanic's Bench Vices
(With Fixed or Swivel Base)



Heavy Duty Drill Vices
(Six Slot Clamping)



Heavy Duty Drill Vices



Bench Grinder Stand



Milling Machine Vices



Heavy Duty Precision
Pipe Vices



Woodworking Vices
Plain Screw



G-Clamp



Lock Down Jaw Machine Vices

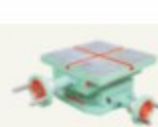

Cross Slide



Tool Post Vices



Angle Plates
(7.1 Machine
7.2 Precision Ground)



AN ISO 9001 : 2015 COMPANY
Mfg. Heavy Duty Precision Vices

ACCORD ENGINEERING CORPORATION

"ACCORD", 4-Atika Industrial Area, Dhebar Road (S), RAJKOT - 360 002 (Guj) INDIA.
Mo : Chaturbhai Gajera : 97264 81272, Ketan Gajera : 99988 44445
Email : sales@accordbenchvices.com | Web Site : www.accordbenchvices.com





HRIDAY ENTERPRISE

All Types Of Industrial Rack Manufacturer



Heavy Duty and Light Duty Industrial Rack



Address : b/s. Yes Bank, Panorama Complex, Chhaniara Building, Opp. Shivalik-7, Opp SBI B/s, Gondal Rd, Rajkot, Gujarat 360002
Mob. : +91-98989 99586, +91-98980 99588
Email : hridayenterprise@gmail.com
Web : www.hriday.chaniaragroup.com



1st Lab of Saurashtra-Kutchh to have **NABL** Accreditation.

WHY CALIBRATION WITH "KRISHNA INSTRUMENTS LLP." ??

- Most standard & advanced master instruments.
- Experienced and trained man power.
- Systematic approach towards handling of instruments.
- Quick delivery - less hold time.
- Established calibration laboratory since **2001**



PRESSURE, VACCUME GAUGE & B.P. INST. (-1 to 300 bar)



TEMPERATURE METER & THERMOCOUPLE



MULTIMETER



CLAMP METER (1000 Amp)

WE CALIBRATE



PROCESS INSTRUMENTS



PT CALIBRATION



TAN DELTA



TACHOMETER (9000 RPM)



POWER ANALYZER



FLOW METER



CURRENT TRANSFORMER (1000 Amp)

- Weight, Balance
- Thermo/Hygro
- Mass Calibration



KRISHNA INSTRUMENTS LLP

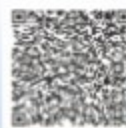

KRISHNA INSTRUMENTS LLP,
 "OM" 5/B, Gopal Nagar, Opp. Gopal Temple,
 Gopal Nagar Main Road, RAJKOT-360002INDIA.
 ☎ : +91 8866 11 7788
 ✉ : Calibration@krishnainstruments.com
 🌐 : www.krishnainstruments.com

An ISO 9001-2015 Certified Company

Microtight

FASTNERS LLP

Your Perfect Partner For Fastening Solution

SOCKET HEAD CAP SCREW (M5 TO M16)

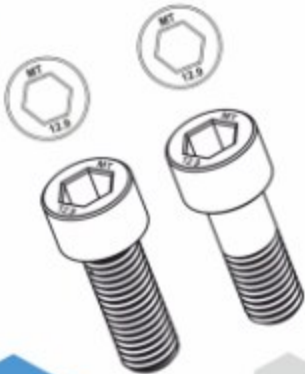

HEX BOLT (M5 TO M16)

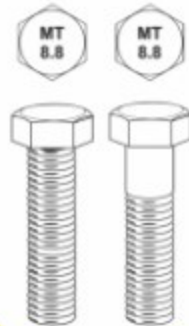

OUR CAPABILITIES

- ▶ 3600 MT/Year
- ▶ Multi Station Forming Machine (Cold Forge Headers M5 TO M16).
- ▶ Thread Rolling Machines.
- ▶ Mesh Belt heat Treatment Furnace.
- ▶ Fully Automatic Zinc/ Zinc-Nickel Electroplating Plant.

- ▶ Well-equipped laboratory-
 - Universal Testing Machine with extensometer for 0.2% proof stress Testing Facility.
 - Rockwell Hardness Testing Machine.
 - Micro Vickers Hardness Testing Machine
 - Salt Spray Testing.
 - XRF (X-ray analysis of coating thickness).
 - Metallurgical Microscope with Image Analyzer.
 - Chemical composition analysis (Spectrometer).
 - Vision Measuring Machine.
 - Non-Distractive testing like MP, DP, UT, RT. With ASNT Level II Qualified technical Staffs

Microtight Fastners LLP

Survey No.: 331, Plot No.: 1 & 2,
Nagar Pipaliya Road, DEVLA,
Taluka : Lodhika, Dist : Rajkot,
Gujarat, INDIA - 360021.

☎ : +91-98240 34150

✉ : amit@microtightfastners.com

🌐 : www.microtightfastners.com

☎ : +91-93753 51003

✉ : info@microtightfastners.com

PHENIX

RESORT

WHERE HOSPITALITY
MEETS LUXURY

PLAY AREA | FINE DINE RESTAURANT | SWIMMING POOL
ROOMS | BANQUET HALL | PARTY LAWN | GYM | CAFE

FOR BOOKING: **+91 74900 45000**
ISHWARIYA ROAD CORNER, KALAWAD ROAD, RAJKOT.