

JANUARY 10, 2025

Volume - 59 Issue - 01

RNI - 11176/67

Price Rs. 50/-

Visit Rajkot Engineering
Association Pavilion



18th - 21st JANUARY, 2025

YESHOBHMI - INDIA INTERNATIONAL CONVENTION
& EXPO CENTRE (ICC), DWARKAM NEW DELHI, INDIA

ACMA Mobility Foundation

Bharat
Mobility
GLOBAL EXPO 2025

RAJKOT ENGINEERING INFORMATION BULLETIN

Postal Regn. No. Rajkot/309/2024-2026

Valid Up to 31-12-2026 Office of Posting RMS-Rajkot.

Published & Posted on dtd., 10th Every Month



**RAJKOT
ENGINEERING
ASSOCIATION**

SINCE 1963

www.reaindia.com

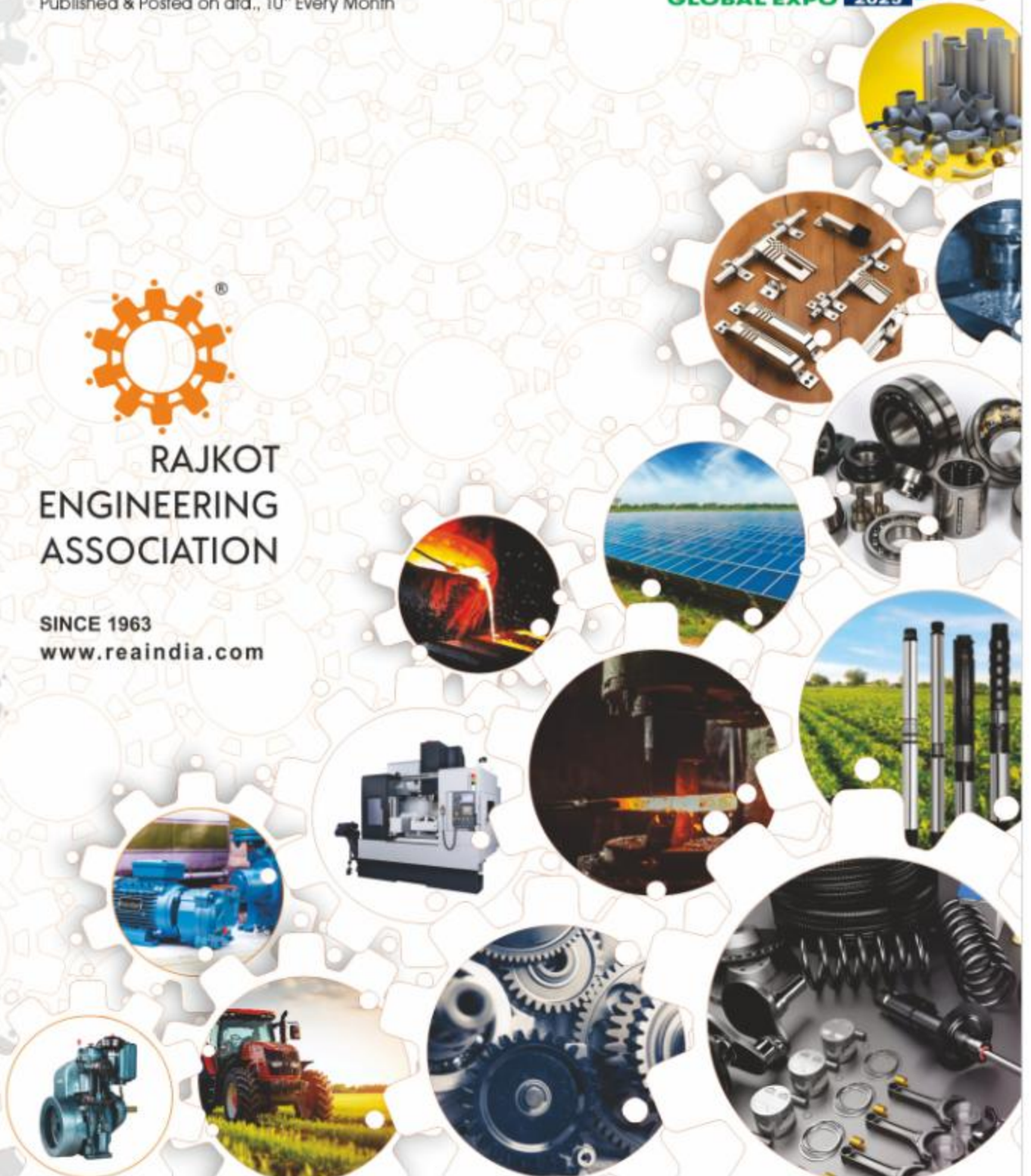

“पहेचान
“नये
“स्वाद की!

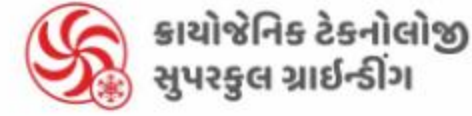

મસાલાને સુપરકુલ ટેમ્પરેચરમાં દળાય છે એટલે મસાલાના ગુણધર્મ સુરક્ષિત રહે છે

દેવપરા આઉટલેટ

કોઠારિયામેઈન રોડ, દેવપરા શાકમાર્કેટ સામે,
રાજકોટ, ગુજરાત - 360002
કોન્ટેક નંબર : +91 99099 20331

અમીનમાર્ગ આઉટલેટ

કે.સી.એલ બિલ્ડીંગ ગ્રાઉન્ડ ફ્લોર, સિટી
સ્કવેર માર્ટ ની સામે, અમીન માર્ગ, ૧૫૦
ફૂટ રિંગ રોડ નજીક, રાજકોટ - 360001
કોન્ટેક નંબર : +91 99099 20489

જુનાગઢ આઉટલેટ

માનસી કોમ્પ્લેક્સ, જનકપુરી,
અંબરડા રોડ, જુનાગઢ - 362001
કોન્ટેક નંબર : +91 99099 13779

Email: sales@farmkingfood.com | Web: www.farmkingfood.com



Farmking Food Products Pvt Ltd

UPLIFT YOUR CLASS WITH
KICH S. S. 316 GRADE PREMIUM QUALITY
ARCHITECTURAL PRODUCTS



Hardware Products



Glass Fittings



Furniture Fittings



Bathroom Fittings



Railing Systems



Digital Solutions

GLIMPSE OF FEW OF OUR PRESTIGIOUS PROJECTS...



CENTRAL VISTA - DELHI



SARDARDHAM BHAVAN
- AHMEDABAD



ATAL BRIDGE- AHMEDABAD



INTERNATIONAL AIRPORT - PUNE



RAM MANDIR - AYODHYA



All India Institute of Medical Sciences
(AIIMS) - RAJKOT



INTERNATIONAL AIRPORT - LUCKNOW



BAPS HINDU MANDIR ABU DABI - UAE

KICH ARCHITECTURAL PRODUCTS PVT. LTD.

Rajkot-Gondal NH-27, Vavdi, Rajkot-360004 (Guj.) INDIA. Helpline: 1800 212 3836 | www.kichindia.com



Discover
Comfort & Style



CLUB ROOM



SUPERIOR ROOM



EXECUTIVE ROOM

Get ready to experience comfort like never before. With plush bedding, state-of-the-art amenities, and intuitive design, your RPJ hotel room is your oasis in the heart of the city.

Our Facilities

- Swimming Pool
- 92 Rooms
- Gym
- Banquets
- 24*7 Coffee Shop
- Restaurants

+91 281 6167777

Everest Park, Kalawad Road, Rajkot - 360005

www.rpjhotelrajkot.com

reservation@rpjhotels.com

RPJ
HOTEL
KALAWAD ROAD, RAJKOT

RAJKOT ENGINEERING INFORMATION BULLETIN

Volume - 59

Issue - 1

JANUARY - 2025

Price Rs. 50/-



RAJKOT ENGINEERING ASSOCIATION

President

Shri Narendra V. Panchani



Vice President

Shri Jignesh S. Adroja



Hon. Secretary

Shri Vinod K. Asodariya



Jt. Hon. Secretary

Shri Chandresh Patel



Hon. Treasurer

Shri Ashish D. Sardhara



Editor

Shri Jay Mavani

INDEX

Sr. No.	TITELS	Page No.
1	EDITORIAL	06
2	DIRECTORY 2024-2025 & BULLETIN RATES	37
3	INSTITUTE NEWS	38
4	TASK SUMMARY	39
5	RAJKOT ENGINEERING ASSOCIATION - AT A GLANCE	47
6	ACTIVITIES OF RAJKOT ENGINEERING ASSOCIATION (REA)	52

Magazine "Rajkot Engineering Information Bulletin" Printed and Published by Mr. Jay Vrajlal Mavani on behalf of Rajkot Engineering Association and Printed at Ajay Printing Press, 2-Patel Nagar, Off. 80 Feet Road, Rajkot-4. and published at Rajkot Engineering Association, Bhaktinagar Industrial Estate Rajkot. Editor-Mr. Jay Vrajlal Mavani

Magazine : Rajkot Engineering Information Bulletin
Volume : 59
Issue : 1
Continuous Issue : 697
Date : 10-1-2025
Page : 84



RAJKOT ENGINEERING ASSOCIATION

Bhaktinagar Industrial Estate, G.I.D.C., Street No.-3, Rajkot-360 002.

Ph. : +91-281-2362235 / 36, Mo. +91 99132 14935

E-mail : info@reaindia.com

Website : www.reaindia.com

Disclaimer : Statements, Opinions and Views given in the news articles and papers appearing in this Bulletin are the expressions of Contributors, for which the Editor and the Association assume no responsibility

સરદાર પત્ર

Vardhman Industrial Zone, Plot No-15, S.V. No.-259 B/h-Kothariya Solvet,
Kothariya, Rajkot - 360002. Gujarat (India), Call : +91 87994 54774



EDITORIAL

Dt. 01/01/2025

CHANGE OF GUARD AT RBI

After a long 6 year reign at the helm of as the Governor of the Reserve Bank of India Shashikanta Das's tenure came to an end on 10th December 2024. It has been the longest tenure for any Governor excepting that of Benegal Rama Rao immediately after independence from 1949 to 1957. However, then the RBI was not an independent and autonomous body and was an Extension of the Finance Ministry. Today the RBI works as a Central Bank very strictly controlling the working of various Government and Private Sector Banks including the Cooperatives and has the full powers to regulate their working including barring them from certain activities in case of irregularities. The US Fed of the USA and the Bank of England of UK enjoy similar independence. RBI is a very important institute to regulate the Banking Sector. It also has the task to manage two contradictory necessities. It regulates the lending rates by the bank by deciding the Repo Rate. When the Repo Rate is reduced the lending rates by the bank are reduced and thereby people get more easy money which leads to increased spending by the people. This boosts the economic activity reflecting in better economic growth. Against this reduction in Repo Rate also leads to Price Rise and Inflation. RBI has the onerous task to balance these two contradictory factors. It is therefore always a thankless job. The regulation of the Repo Rate is done by the MPC - Monitoring Policy Committee. This committee meets every 3 months to take a decision on the Repo Rate and is Chaired by the Governor. Shashikanta Das kept the Repo Rate unchanged during the last 11 consecutive MPC meetings - a bold decision. Bold because there was a constant pressure - in particular during the last few times - to decrease the Repo Rate from the Government of India's heads of Finance and Commerce Departments : Nirmala Sitaraman and Piyush Goyal. To be fair to Shashikanta Das we can certainly say that he had to face a very turbulent time not only within the country but in the entire world. There was a once in a century calamity of the Covid followed by the Wars between Russia-Ukraine and Israel-Palestine. He kept the economy by and large stable during these torrid times. The new incumbent in place of Shashikanta Das - Sanjay Malhotra has a daunting task on hand. For the first time after several quarters the Indian Economy seems to be slowing down. Asia development Bank has pegged the GDP growth estimate for India at 6.5% down from the earlier forecast of 7%. RBI's own estimate has been downgraded from 7.2% to 6.6%. For this very reason both Nirmala Sitaraman and Piyush Goyal have been pressing the RBI for a Repo Rate reduction. Concurrently there is going to be a change of guard in USA as well which is very likely going to affect badly the Dollar-Rupee exchange rate. Trump is very likely going to shake up the whole approach to Economy taking revolutionary and drastic measures. The first thing he is going to do after assuming office is to change the US Fed Chairman Jerome Powell.

Jaybhai Mavani Cell : 98242 13751
E-mail : sales@turnmax.in



KRISHNA CASTING



**Manu. ALL KIND OF C.I.
GRADED CASTING**



Address : Jilla Garden Main Road, 4, Bapunagar,
Rajkot - 36002, (Gujarat), India **Phone No :** 281 2232005
Email : krishnacasting@yahoo.com, **Web.:** www.krishnacasting.com
Bhavesh Vagharia Mo. : 98795 99979

સરદાર પત્રા

Vardhman Industrial Zone, Plot No-15, S.V. No.-259 B/h-Kothariya Solvet,
Kothariya, Rajkot - 360002. Gujarat (India), Call : +91 87994 54774





:: PRESIDENT MESSAGE ::

Dear friends,

Rajkot Engineering Association participates in the Auto Expo Components International Show which held every two years in India and now Auto Expo the Components Show as Bharat Mobility Global Expo -2025, Auto Expo - The Component Show, to provide persistent industry branding.

Here, efforts are being taken to promote the industries of Rajkot, especially automobiles, by booking a biggest space named RAJKOT ENGINEERING ASSOCIATION PAVILION by our Association to accommodate all type of manufacturing unit members also at affordable price and eventually products of the industries of Rajkot region could fascinate the universal buyers and proved the Rajkot as one of the biggest international engineering hubs.

The 17th BMGE -2025 is going to organise at Yashobhumi, Dwarka - New Delhi, during 18th to 21st January, 2025, under approximately 1100 Sq. Mtrs. raw space covered and 50 entrepreneurs of Rajkot have possessed stalls at reasonable prices through our Association. I hope that a sincere effort is being taken by the entrepreneurs of Rajkot to realize the concept of "Make in India".

I wish all the best wishes that automobile industry of Rajkot will reach the pinnacle of India as well as globally.

Narendra Panchani
President
Rajkot Engineering Association



AATOMIZE®

NEVER COMPROMISE

BUSINESS OPPORTUNITY

FULLY STONELESS UPTO 10,000 KG FLOUR PLANT



MASALA PULVERIZER

3HP TO 30HP



1
NUMBER ONE in Grinding Solution

- Domestic Flourmill
- 2 in 1 Auto Pulverizer
- Masala Machine
- Sugar Grinding Machine
- Rice Mill Machine
- Dal Machine
- All Types of Food Processing Machinery

AATOMIZE MANUFACTURING PVT. LTD.

Shapar (Veraval), Rajkot-360024, Gujarat (INDIA).

www.aatomize.com | For Inquiry : 87390 87390



સરદાર પત્ર

Vardhman Industrial Zone, Plot No-15, S.V. No.-259 B/h-Kothariya Solvet, Kothariya, Rajkot - 360002. Gujarat (India), Call : +91 87994 54774





Best Performance Award
IPMA Award 2019

NEW PRODUCT

ડોનેક્સ સર્ફેસ પ્રોટેક્ટર

DONEX SURFACE PROTECTOR 1:7

PINK LIQUID

આ લિક્વિડ ૧ ભાગ + ૪ ભાગ પીવાનું પાણી = કુલ ૫ ભાગ કરવું.
સબમર્શીયલ મોટરમાં ભરો, ટેસ્ટીંગ કરો, કાઢી નાખો અને રિચુઝ કરો
આમ કરવાથી, ડીલર ને ત્યાં ૧ વર્ષ પડી રહેલી મોટર્સ પણ ચોક-અપ કે જામ નહિ થાય તેથી રિપ્લેસમેન્ટ ઘટશે.

Dilution Ratio For Self Priming pump filling purpose-1+7 = 8

MAHIR®

Surface Protector

SUBMERSIBLE PUMP GRADE - 1:3

For permanent motor filling purpose



- Non Amines Liquid
- Extra Lubrication
- Always free flowing
- Anti-Corrosive Liquid

• NO SIDE EFFECTS ON RUBBER TAPE •

- Best Cooling Properties
- Long Life to inside parts
- Nearly food Grade
- Saves Small Electricity

Some of Our Valued Customers

- Texmo-Taro • Texmo • Aquasub • CRI Pumps • Kirloskar • Varuna • Pluga (Franklin - USA)
- Lubi • Samudra • Laxmi • LADA • Panelli - Italy • Unnati • Hayat • Silver • Ajanta • Angel
- Duke • Oswal • Teraflo • Flotech • Rotec • Aden • Penguin etc. So many pump Mfg. companies.



Manufactured by :
Gokul Coolant Industries
330, PANORAMA COMPLEX, OFF. BAL ADALAT, GONDAL ROAD, RAJKOT - 360002 (Guj.)
M: +91-283-2233750 | F: +91 90811 96900 | Email: info@indiacoolant.com | www.indiacoolant.com



An Anti-Corrosive Cooling Liquid With Extra Lubrication

સરદાર પતરા

Vardhman Industrial Zone, Plot No-15, S.V. No.-259 B/h-Kothariya Solvet,
Kothariya, Rajkot - 360002. Gujarat (India), Call : +91 87994 54774

SARDAR
INDIAN PUMP



+91 99251 04296

info@nandiniind.com

www.nandiniind.com

Atika Ind. Area-2, Opp. Kisan Way Bridge, Atika Dhebar Road(South) Rajkot-2.

Mfg. ALL TYPE OF C.I. CASTING

Molding Process

- Molasses Sand Casting
- Green Sand Casting
- Nobake Casting
- Shell Core Casting

Auto Parts Hydraulic Parts



Fire Safety Hydrant Valve Body

Grinder & Induction Motor Body Parts



Pump Housing Casing Flange

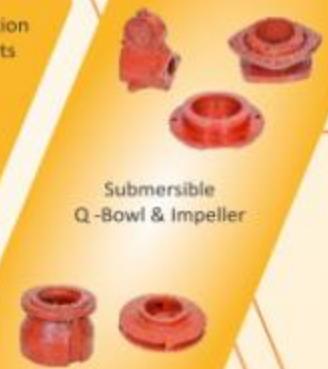

Submersible Q-Bowl & Impeller

Machine Tools



MEERA CASTING
Mfg. : All Kind of C.I. & S.G. Casting

Induction Motor



Gear Box



Industries served

- Electric motor
- Machine tools
- Gear box
- Pumps and Valves



Manufacturer of Grey Iron and SG iron with facility like Induction furnace from Inductotherm, Continuous sand mixer and Reclamation from Omega UK, Fully equipped Laboratory containing Spectrometer from Bruker Germany, Microscope from Metalsoft with image analyser, UTM, Hardness Tester, sand testing equipments, Shot blasting, Fettling, Painting booth etc...



Survey No. 167, Kothariya Village Main Road, Village Lothada, Rajkot (Gujarat) INDIA.
E-mail : info@meeracasting.com

સરદાર પત્રા

Vardhman Industrial Zone, Plot No-15, S.V. No.-259 B/h-Kothariya Solvet, Kothariya, Rajkot - 360002. Gujarat (India), Call : +91 87994 54774





WORLD CLASS TESTING AUTOMATION
FOR ALL KIND OF PUMP & MOTOR
WITH IN-HOUSE NABL LABORATORY



WORLD'S
1st



INDUSTRIES
SERVED



Fully Automatic
 (NO Load)
 Routine Test Panel

Smart Power Analyzer
 with
 Pump and Motor
 Evaluation parameter

Electromagnetic
 Flowmeter

More than
5000+
 Customers world-wide

More than
200+
 Standard Products

More than
100000+
 Installation world-wide

AAROH EMBEDDED SYSTEMS PVT. LTD.

THE COMPANY FOUNDED BY ALUMNUS OF IIT, BOMBAY



Plot No. G-(1004-8)A, Kishan Gate No-3 Main road, Nr. Durga Weigh Bridge, GIDC Metoda, Village Lodhika, Kalawad Road, Rajkot, Gujarat (India.) - 360021.

+91-02827 297280

+91 95129 99942



www.aarohies.com

Email: Info@aarohies.com



NIKOO
TECHNOCAST
 "Casting Metal to Life"

"Mfg Of Ductile Iron, Cast Iron & Precision Machined Components."

ONE STOP SOLUTION FOR ALL YOUR CASTING REQUIREMENTS

We Believe In Cultivating Lifelong Relationships. We Welcome You To Join Nikoo Family.



+91 74059 87299

www.nikootechnocast.com

Info@nikootechnocast.com

Veraval (Shapar), Rajkot

સરદાર પત્રા

Vardhman Industrial Zone, Plot No-15, S.V. No.-259 B/h-Kothariya Solvet, Kothariya, Rajkot - 360002. Gujarat (India), Call : +91 87994 54774



आपकी हर जरूरत का साथी

Speedwel®



परिवार रहे
स्वस्थ
जब आटा
मिले स्वच्छ



SHEETAL LEHER
AIR COOLERS

गर्मी में सिर्फ
शीतल लहेर
सुपर हिट

SpeedHot

WATER GEYSER

अब स्पीड हॉट गीजर
के साथ गरम पानी
पाना एकदम आसान



Manufacturer & Exporter (An ISO 9001:2015 Certified Company)

GUJARAT FORGINGS PVT. LTD.

Opp. N.S.I.C., 80 Feet Road, Aji Industrial Area, Rajkot - 360 003 (India).

Email: info@fieldmarshalengine.com | Customer Care No. +91 99740 56831/32/34

Web: www.speedwel.com | Follow us: [f](#) [t](#) [i](#) [c](#) [o](#) [i](#) [n](#) [s](#) @Speedwel | [c](#) [o](#) [c](#) +91 99740 56831

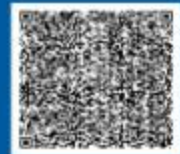

सरधर पत्र

Vardhman Industrial Zone, Plot No-15, S.V. No.-259 B/h-Kothariya Solvet,
Kothariya, Rajkot - 360002. Gujarat (India), Call : +91 87994 54774

SARDAR

Since : 1982



WELDING TECHNOLOGY



AN ISO 9001:2015
CERTIFIED COMPANY

Manufacturers of :
All Type of ARC Air & Oil Cooled Welding Machine, Spot Welding, Pneumatic Type Spot Welding, Hand Spot Welding, ARC Inverter Welding, Tig Welding, Mig Welding, Plasma Cutting, Welding Equipments & Step-up Transformers.



ARC

SPOT

PNEUMATIC

INVERTER TIG

INVERTER MIG

INVERTER CUT

Always ahead for it's quality, workability & availability



Regd. Office :
 Plot No. C-D-38, 4, Atika Ind. Area, Weldor Street,
 Kishan Chowk, Dhebar Road (South), RAJKOT-360 002. (INDIA)
 Phone : +91-281-2361937, 2365621, Mob.: 9978975261
 e-mail : rajlaxmiwelding@yahoo.com
 web : www.welding-transformer.com

We are an ISO 9001:2015 Company, established in 1983 based in Rajkot and continuously working with Best Quality, Best Price & Timely Deliveries as its mission ever since. SQC is engaged in manufacturing of different types of Investment Castings by lost wax process for Submersible Pumps, Process Pumps, Centrifugal Pumps, Industrial Valves, Cam-Lock Couplings, Aerospace, Agriculture Equipments, Construction Equipments, NRV Couplings, Plumbing Valves, Railways, Marine, General Engineering, Automobiles, Firefighting Range, Food Industries, Dairy & Textile Machineries, Ortho Implants etc. in Ferrous metals such as Stainless steel, Alloy steel, Carbon steel, Duplex steel, Super alloys amongst others and Brass in Non- Ferrous segment.



"we Cast What You Think"











Unit 1 : Behind Rajkamal Petrol Pump, Off Gondal Road, RAJKOT - 360 004. GUJARAT (INDIA)

Unit 2 : Survey No. 216, Muktidham Road, Before Railway Crossing, Veraval (Shapar) - 360 024. GUJARAT (INDIA)



SUPER QUALI CAST (INDIA) PYT. LTD.
 MFRS. : PRECISION INVESTMENT CASTINGS

☎ 91-281-2388848 ✉ info@superqualicast.com 🌐 www.superqualicast.com

સરદાર પતરા

Vardhman Industrial Zone, Plot No-15, S.V. No.-259 B/h-Kothariya Solvet, Kothariya, Rajkot - 360002. Gujarat (India), Call : +91 87994 54774



Amit Hansalia
+91-99740 38980

An ISO 9001 : 2015 Certified Company

Vijal Gandhi
+91-99740 12322

Shakti

Shakti Heat Treaters & Engineers

Specialist in All type of Heat Treatment process

A Well known and one of the Biggest Heat Treatment Company in the Region
Having More than 100 Customers.

- Forgings
- Investment Castings
- Sand Castings
- S.G. Iron
- C.I. Castings

Machinery

- Gas Fired Pit Type Furnace Temp. 1200 °C
- Gas Fired Pit Type Air Circulated Tempering Furnace
- Electric Pit Type Atmosphere Controlled Carburising Furnace
- Electric Pit Type Air Circulated Tempering Furnace
- Electric Pit Type Air Circulated Solution Treatment Furnace working temp. 1200 °C
- Oil Quenching Tank - 30000 ltr & 12000 ltr
- Water Quenching Tank - 35000 ltr, 15000 ltr & 10000 ltr
- Online Temperature Monitoring Systems

We do

- S.R. Normalizing, Annealing,
- Hardening, Tempering
- Precipitation Hardening, N.Q.T.
- Solution Annealing Upto 1200 °C
- Oil & Water Quenching
- Carburising, Case Hardening

Testing Facility

- Brinell Hardness Tester Computerized
- Rockwell Hardness Tester
- Micro Vickers Hardness Tester
- Portable Hardness Tester
- Microscope

Job Capacity Up to - 1.5 tons Single Pcs
(2300 MM length x 1300 MM Dia)



Office & Works - Unit - 1

Survey No. 163/1-P, Plot No. 3, SIDC Road,
Veraval (Shapar) Tal. Kotasangani, Dist. Rajkot
Phone No.: +91 - 2827- 252067
Email : shaktiheat@gmail.com

Works - Unit - 2

Survey No. 225, Plot No. 39/40/41, Shreenathi
Industrial Zone, Near Gundasara Railway Crossing,
At. Gundasara Village, Tal. Gondal, Dis. Rajkot

Manufactured with
Quality "Telegraphic Channels"

EISEN

Eisen Hardware Solutions Pvt. Ltd.
Hq. - Industrial Estate & Technology Park
Rajkot (Gujarat) INDIA
www.eisenhardware.com

OEM
AVAILABLE



Premium
Quality

- Extra Smooth 3 Ball Runner
- Load Capacity 45 kg.
- Long life Locking System
- 120hours slot spdy Tested
- Extra Full Extension
- German Technology Plating
- Available Length 10 to 24 inch
- Finish :- Zinc, Black



સરદાર પત્ર

Vardhman Industrial Zone, Plot No-15, S.V. No.-259 B/h-Kothariya Solvet,
Kothariya, Rajkot - 360002. Gujarat (India), Call : +91 87994 54774

SARDAR
Sardar Group of Institutions

PC POINT

QUALITY START WITH US.

WE PROVIDE SOLUTIONS

Server, Computer, Laptop Sales & Service

Hardware & Networking Services

Annual Maintenance Contract (AMC)

IP / CCTV Camera Solution / Installation

Network Security Solution

All Type of Corporate Office Communications Solutions (Video Conference System, EPBX, etc.)



Sagar Parsana
+91 98981 02907
+91 90333 28628
pcpointcare@gmail.com

"Samrudhi bhavan",
Shop No.74, 3rd floor Gondal rd,
Opp. bombay petrol pump,
Rajkot - 360002



AN ISO 9001 : 2008 Certified Company



Web : www.honestyengworks.com
E-mail : info@honestyengworks.com
Mobile : +91 8000 382199 (KRUNAL)



HONESTY ENGINEERING WORKS

Manu. of High Tensile Bolt, Studs, Nut, Center Bolt & I Bolt

Office: 2, Bhaktinagar Station Road, Rajkot-2. Ph.: 0281-2461040
Factory: 9, Aji Vasahat, 80 Feet Road, Rajkot-3. Ph.: 0281-2389009 Cell : 098240 76100



MANUFACTURERS OF
SCREW TYPE AND RECIPROCATING TYPE
SINGLE STAGE & DOUBLE STAGE
AIR COMPRESSORS

ALSO DEALS IN AIR DRYER, SERVICE PUMP, GREASE PUMP, OIL FREE AIR COMPRESSOR
TRACTOR MOUNTED AIR COMPRESSOR AND OTHER PNEUMATIC ACCESSORIES



Screw Air Compressor Reciprocating Single Stage Single Cylinder Reciprocating Single Stage Double Cylinder Reciprocating Double Stage Double Cylinder



Reciprocating Double Stage Three Cylinder High Pressure Air Compressor Service Pump Grease Pump



Office : 99130 00962 Accounts : 94087 09277
Service : 99130 00961 Sales : 99042 99969, 96735 33982
Web : www.toyo.in Email : info@toyo.in

For **UNMATCHED Quality PERFORMANCE**



टोपलैंड
Topland
توب لاند
topland-india.com

India's 1st Export Brand in WATER & POWER SOLUTIONS



an ISO 9001 2015 certified company



हम हैं भारत के नं.1 एवं एकमात्र निर्माता

जो आपकी हर जरूरत के अनुसार उत्पन्न करते हैं।

Topland Assorted Product Range :

- Diesel / Petrol Engine / Pumps : 1.5 HP to 500 HP
- Pumps / Monobloc / Openwell : 0.5" x 0.5" to 14" x 14"
- V3 to V10 - Submersible Pumps : 0.5 HP to 320 HP
- A.C. Generator/Silent Genset : 1 KVA to 200 KVA
- Domestic Flour Mill : 1 to 3 HP
- uPVC & PVC & SWR Pipes & Fittings upto 2" Size
- Suction Hose Pipes upto 8" Size
- Garden Pipes upto 1.5" Size
- HDPE Pipes upto 4" Size
- Agri Pipes upto 10" Size
- Column Pipes upto 4" Size
- Rotavator : 4' to 8' (Feet)



Manufacturer & Exporter :

Topland Engines Pvt. Ltd.

3, Chokrasani Park, Lohang Nagar, Main Post, Rajkot - 360 004 (GJ)
Phone : +91 291 238811/2/3, 238022/3/4 Mobile : +91 93741 28002
E-mail : topland_india@toplandengines.in export@toplandengines.com

Toll Free : 1800 233 88888

topland-india.com

An ISO 9001:2008 Company

सरधर પત્ર

Vardhman Industrial Zone, Plot No-15, S.V. No.-259 B/h-Kothariya Solvet,
Kothariya, Rajkot - 360002. Gujarat (India), Call : +91 87994 54774





15 kg to 1000kg
Green Sand and No back Process

CI & SG Iron Casting - as per Your Pattern.

Accord Inducto Cast

Quick Contact 'ACCORD', Plot NO.5,
Survey No.45, Nr. Bharat Nagar,
Vavdi, Rajkot - 360004,
Gujarat - INDIA.



Valve and Pump Castings



Gear & Transmission Parts

Mr. Ketan Gajera

+91 99988 44445
sales@accordcasting.com
www.accordcasting.com



Machinery Castings

Excellent Attitude &
Performance Lead to Quality



AN ISO 9001 : 2015 COMPANY



THE **100%** PERFECT CHOICE FOR
YOUR WORKSHOP



Mechanic's Bench Vices
(With Fixed or Swivel Base
Oxford Blue Color)



Mechanic's Bench Vices
(With Fixed or Swivel Base)



Heavy Duty Drill Vices
(Six Slot Clamping)



Heavy Duty Drill Vices



Bench Grinder Stand



Milling Machine Vices



Heavy Duty Precision
Pipe Vices



Woodworking Vices
Plain Screw



G - Clamp



Lock Down Jaw Machine Vices



Cross Slide



Tool Post Vices



Angle Plates
(7.1 Machine
7.2 Precision Ground)



AN ISO 9001 : 2015 COMPANY
Mfg. Heavy Duty Precision Vices

ACCORD ENGINEERING CORPORATION

"ACCORD", 4-Atika Industrial Area, Dhebar Road (S), RAJKOT - 360 002 (Guj) INDIA.
Mo : Chaturbhai Gajera : 97264 81272, Ketan Gajera : 99988 44445
Email : sales@accordbenchvices.com | Web Site : www.accordbenchvices.com



સરદાર પત્રા

Vardhman Industrial Zone, Plot No-15, S.V. No.-259 B/h-Kothariya Solvet,
Kothariya, Rajkot - 360002. Gujarat (India), Call : +91 87994 54774





We are an IATA accredited travel Company. We make your travel economical, safe, fun, informative, comfortable & memorable.

We feel obliged to introduce our ambitious venture "PATEL HOLIDAYS" as an entity which takes care of any tour & travel requirements of its estimated time at global level. Since inception, in 2006, we have been an IATA accredited travel Company.

PATEL HOLIDAYS has been venturing into a new geographic arena and making utmost effort to make the best deal available to its clients.

- Holidays Tour Package (Inbound & Outbound), Family Group Package, Corporate Groups, Dealers Group, MICE & Student Groups, Teacher Groups & Spiritual Tours.
- Airticket (Domestic & International).
- Gulf country VISA stamping including medical.
- Passport processing (New & Renewal) & Student Passports & Groups.
- Travel insurance.
- Worldwide Hotel Bookings.
- Tourist Visa, Business Visa, Conference Visa.

PATEL HOLIDAYS is a one-stop enterprise that offers the complete range of travel related services. Superior knowledge, efficient planning and the ability to anticipate & resolve potential problems along the way are the reasons behind our success.

Till date, we have handled over 50,000 guests who have taken advantage of our valuable services.

We are awarded for the excellent performance of selling Yas Island for the year 2023 by Abu Dhabi Tourism.



MR. SHAILESH PADARIYA

Founder Director
Patel Holidays

Our Expertise

U.K & USA Passport Renewal,
Schengen Visa (Europe), Australia,
Canada, China Tourist & Business Visa

Specialised in Group Tour

Dubai, Japan, Singapore, Malaysia,
Thailand, Bali, Vietnam, Europe, South
Africa, Himachal, Kashmir, Leh-ladakh,
Goa, Andaman-Nicobar, Kerala,
Karnataka, Uttarakhand, Sikkim.



OUR AWARDS



OUR PRESENCE

- RAJKOT HEAD OFFICE -
3rd Floor - Kevalam Complex,
B/H Umiya Mobile,
Astron Chowk, Rajkot - 360001
☎ +91 98791 24774

- RAJKOT BRANCH OFFICE -
115, Shivam Complex,
Sarweshwar Chowk, Jagnath Plot,
Dr. Yagnik Road Rajkot - 360001
☎ +91 63527 64669 / +91 72850 26567

- AHMEDABAD OFFICE -
612, Aaron Spectra,
Rajpath Rangoli Road,
Bodakdev, Ahmedabad - 380054
☎ +91 96621 61109 / +91 94281 54133

- SURAT OFFICE -
U-4, Jolly Square, Nr. Ram Chowk,
Ghod Dod Road, Surat - 395001
☎ +91 75979 5238 / +91 97261 11880

- JAMANAGAR OFFICE -
138, Avadh Viceroy, Sarthana
Jakat Naka, Nana Varachha,
Surat - 395006

- JETPUR OFFICE -
152, Neo Square,
Ambar Cinema, Jamnagar-361001
☎ +91 76983 08248

- JETPUR OFFICE -
IB Complex, Junagadh Rd,
Jetpur - 360370
☎ +91 87348 86500

PATEL HOLIDAYS
TRAVEL SOLUTIONS PVT. LTD.

☎ +91 98791 24774
✉ shailesh.patelholidays@gmail.com

સરદાર પતરા

Vardhman Industrial Zone, Plot No-15, S.V. No.-259 B/h-Kothariya Solvet,
Kothariya, Rajkot - 360002. Gujarat (India), Call : +91 87994 54774



VISHAL
SUBMERSIBLE PUMP SET

MFG. :
V-3, V-4 SLIM, V-4, V-5,
V-6 BORWELL &
OPENWELL SUBMERSIBLE PUMPSET

VISHAL ENGINEERS
Golden Industrial Area, Plot No. 6, B/h. Rolex Rings Pvt. Ltd.,
Railway Crossing, Opp. Krishna Park Hotel, Gondal Road,
Village : Kothariya - 360 022. Dist. Rajkot.
E-mail : Vishalengineers2012@gmail.co
Web : www.vishalpump.com
Cell : 094271 55599 / 94274 60888 / 099791 11055

ACCURATE
Precision Lathe Machines & SPMs

High Speed All Geared
Lathe Machines

Heavy Duty All Geared
Lathe Machines

Heavy Duty
Lathe Machines

Extra Heavy Duty
Lathe Machines

Exported to Countries:

ACCURATE MACHINE TOOLS
www.accuratelaathe.com

11, Aitika Industrial Area,
Dhokar Road South,
Rajkot - 360 002, INDIA.

Phone: +91 281 2331077
Mobile: +91 98262 22668
E-mail: info@accuratelaathe.com

VEDANT LOGISTICS

Combining the latest logistics technology with high-quality services, and the ability to offer customised solution

Our Services :

- Export & Import air & sea freight
- Custome Brokerage
- Ad Code Registration
- Self Sealing Permission
- Rex Registration
- Coastal Services
- Transportation

Our Network :

- Kandala
- Mundra
- Nhava Sheva (Mumbai)
- Ahmedabad ICD
- AIR - Ahmedabad
- AIR - Mumbai
- Hazira
- ICD Vernama (Baroda)
- Chennai & Major Ports

CONTACT US :

Registered Office
Vedant, Geet Gurjarl Society,
Street no. 2, Airport Road, Rajkot -
360007, Gujarat, India
Email ID
info@vedantlogistics.co.in
Cell
+91 90990 12199 / 94080 04365

Satisfaction of Quality

PRECISION SINTERED PRODUCTS

**World Class Manufacturer of
Sintered Bushes & Powdered Metal Structural Parts**

Plot No.2611, Lodhika G.I.D.C. Estate, Road - D, Kranti Gate,
METODA (RAJKOT)-360021 (Gujarat, INDIA.)
Office +91 93774 82688 M. 98253 66380 | 98256 95322
E-mail : precision@sintered.in | mails@precisionsintered.com
Web : www.sintered.in | www.precisionsintered.com



HRIDAY ENTERPRISE

All Types Of Industrial Rack Manufacturer



Heavy Duty and Light Duty Industrial Rack



Address : b/s. Yes Bank, Panorama Complex, Chhaniara Building, Opp. Shivalki-7, Opp SBI B/s, Gondal Rd, Rajkot, Gujarat 360002
Mob. : +91-98989 99588, +91-98980 99588
Email : hridayenterprise@gmail.com
Web : www.hriday.chaniaragroup.com



1st Lab of Saurashtra-Kutchh to have **NABL** Accreditation.

WHY CALIBRATION WITH "KRISHNA INSTRUMENTS LLP." ??

- Most standard & advanced master instruments.
- Experienced and trained man power.
- Systematic approach towards handling of instruments.
- Quick delivery - less hold time.
- Established calibration laboratory since **2001**

WE CALIBRATE

PRESSURE, VACCUME GAUGE & B.P. INST. (-1 to 300 bar)	TEMPERATURE METER & THERMOCOUPLE	MULTIMETER	CLAMP METER (1000 Amp)
PROCESS INSTRUMENTS	PT CALIBRATION	TAN DELTA	
TACHOMETER (0000 RPM)	POWER ANALYZER	FLOW METER	CURRENT TRANSFORMER (1000 Amp)

- Weight, Balance
- Thermo/Hygro
- Mass Calibration



KRISHNA INSTRUMENTS LLP.
 "OM" 5/B, Gopal Nagar, Opp. Gopal Temple, Gopal Nagar Main Road, RAJKOT-360002INDIA.
 ☎ : +91 8866 11 7788
 ✉ : Calibration@krishnainstruments.com
 🌐 : www.krishnainstruments.com

સરદાર પત્રા

Vardhman Industrial Zone, Plot No-15, S.V. No.-259 B/h-Kothariya Solvet, Kothariya, Rajkot - 360002. Gujarat (India), Call : +91 87994 54774



"Don't be a fool - use the proper tools"

SAFETY PRODUCTS | PPE PRODUCTS | FIRE SAFETY
ROAD SAFETY | POWER TOOLS | TOOLS ABRASIVES
WELDING SOLUTIONS | PACKAGING | PAINTS ADHESIVES
HAND TOOLS | ELECTRIC MOTORS



Email : omtrading139@gmail.com | Mo. 72039 00139, 97235 92165
G/911-A, Kishan Gate, Lodhika G.I.D.C., Kalawad Road, Metoda, Dist. Rajkot (Guj)-360021.



MATRIX WEIGHBRIDGE & INTELLIGENT TERMINAL

PIT LESS WEIGHBRIDGE



PIT MOUNTED WEIGHBRIDGE



MODULAR WEIGHBRIDGE



1 INTEGRATED INTELLIGENT TERMINAL

Product Features

- ✦ Rugged And Robust Design
- ✦ High Record Storage
- ✦ High Strength Structure
- ✦ Designed For Harsh Environment
- ✦ Easy Transportation And Installation
- ✦ Designed And Manufactured Very Precisely
- ✦ Minimum Installation Time
- ✦ Easy Maintenance And Cleaning

Matrix Weighing Systems Pvt. Ltd.

Plot no. 12, Survey no. 32, Rajkot Gondal Highway,
Behind TATA Perfect, Beside Poonam Dumper,
Vavdi, Rajkot - 360 004, Gujarat, INDIA.

Cell.: +91 98250 75183

+91 90990 92850

Email: info@matrixwb.com

Web: www.matrixweighbridge.com



સરદાર પત્રા

Vardhman Industrial Zone, Plot No-15, S.V. No.-259 B/h-Kothariya Solvet,
Kothariya, Rajkot - 360002. Gujarat (India), Call : +91 87994 54774





A COMPLETE PRINTING & PACKAGING SOLUTION



CATALOGUE
PAPER BAGS



POUCHES
PRINTED LABELS



PREMIUM BOXES
AND MANY MORE...



DUPLEX BOXES
CORRUGATED BOX



PRINTWELL OFFSET
37B/A, AJI G.I.D.C MAIN ROAD, NR. BAVISHI WEIGHT BRIDGE,
OPP. SAHKARI MANDLI,RAJKOT - 360 003, (GUJARAT) INDIA.

CONTACT US : + 91 93777 15636

FOLLOW US ON :



WWW.PRINTWELLRAJKOT.COM
WWW.MULTITONPOLYPACK.COM

MULTITON POLYPACK PVT. LTD.
PLOT NO.-219, AJI G.I.D.C, PHASE - II, MAIN ROAD,
220A, N-ROAD, RAJKOT - 360003, (GUJARAT) INDIA.
MPPL (UNIT - 2)
SURVEY NO. 284/1, 284/2, NEAR RK UNIVERSITY,
KASTURBADHAM (TRAMBA),
RAJKOT-BHAVNAGAR HIGHWAY - 360020

CONTACT US : +91 99139 99949, +91 76210 02030

Vipul Patel +91-98791 74713 Office +91-98791 72466

SHIVAM MINERALS & ALLOYS
Supplier of all types of Ferrous & Non Ferrous Metals

SHIVAM Group of Company
"Providing Quality to Inspiring your Trust"

Athorised Dealer
CUMI murugappa Carborundum Universal Limited

Nickel
Ferro Moly
Ele Iron
Fe Manganese Lc.
Fe Chrome Lc.

- Ferro Silicon (Metal,Zirc.,Cals.)
- Manganese (Metal,Lc,Mc,Hc)
- Chromium (Metal,Lc,MC,HC)
- Nickel (Falcon,Inco,Chips)
- Molly Metal & Ferro Molly
- Zinc Ingot (Hindustan)
- Iron Lumps (Hoganas)
- S.S. Melting Scrap
- Tin (Metal & Ingots)
- Ferro Vanadium
- Aluminum shots
- Selenium Metal
- Tungsten Metal
- Cobalt Metals
- Ferro Titanium
- Ferro Niobium

Sixty Eight METALS

+91-74054 47074
+91-63539 44531
www.sixtyeightmetals.com

PRECISION TECHNOCAST PVT. LTD.
+91-90991 11796
Ph. - 02827-296001
www.precisiontechnocast.com

ARKH DEVELOPERS
+91-98791 74713
www.arkhdevelopers.com

Plot No.-10, Opp. Sardar Starch,
Nr. Gujarat Alloy Cast, Pan Business Park Gate,
Shapur (Veraval)-360 024 (Guj.) INDIA - Ph. :- 02827 - 299263
Email :- shivammineralsandalloys@gmail.com
Web :- www.shivammineralsandalloys.com



Vardhman Industrial Zone, Plot No-15, S.V. No.-259 B/h-Kothariya Solvet,
Kothariya, Rajkot - 360002. Gujarat (India), Call : +91 87994 54774



GUGAN

SURFACE FINISHING AUTOMATION
AND ELECTROPLATING PEOPLE



SINCE 2014
7 YEARS OF EXCELLENCE
Innovation, Quality, Commitment

About Our Company

Gugan Engineering Company founded in year 2014, set out itself to be a leading solution providers in surface finishing industry. GEC, was formed by first generation entrepreneurs & technocrats. The company has a strong research base with technology, research and development. Gugan Engineering established the state of art manufacturing facility to offer customers and clients the best of technology in industry.

Process lines are specifically designed for all types of surface finishing applications. multiple manufacturing facilities permit flexible customization for every customers need and unique application and delivery requirements.

Our Expertise

- ❖ Alkaline Zinc Plating Plant
- ❖ Zinc Nickel Plating Plant
- ❖ Acid zinc Plating Plant
- ❖ Copper Plating Plant
- ❖ Anodizing Plant
- ❖ Phosphating Plant
- ❖ ABS Plating Plant
- ❖ PCB Plating Plant
- ❖ Silver Plating Plant

Process Automation of Plating Industry

- ❖ Process Efficiency
- ❖ Cycle Optimization
- ❖ Productivity Improvement
- ❖ Mixed Cycle Program
- ❖ ERP / SAP Integration
- ❖ Energy Management in Plating Plants



Contact us for your automatic plating line requirements

GUGAN ENGINEERING COMPANY

No: 60/2A & 61/2A, Chettiyar Agaram Main Road, Chettiyar Agaram, Chennai - 600077
9894164686, 9043896720 | arun@guganengg.com | www.guganengg.com

સરદાર પત્ર

Vardhman Industrial Zone, Plot No-15, S.V. No.-259 B/h-Kothariya Solvet,
Kothariya, Rajkot - 360002. Gujarat (India), Call : +91 87994 54774

SARDAR
Engineering & Technology

SINCE : 2000



TOP SAFETY
QUALITY
CUSTOMER
SATISFACTION



LIFT MFG., MODERNIZATION & MAINTENANCE



2,500+
Elevators
Manufactured



400+
Client Base



20+
Cities in India



Our Products :

- Passenger Lift
- Capsule Lift
- Hospital Lift
- Goods Lift
- Dumbwaiter
- Car Lift
- Hydraulic Lift

TOP INDIA ELEVATOR PVT. LTD.

Head Office :

205 - B, Crystal Commercial Complex.,
Nr. K.K.V. Hall, 150 Feet. Ring Road,
Rajkot - 360005. Gujarat. INDIA.

Phone : 0281-2587835

Mobile : + 91 - 9924130748

E-mail : info@topindiaelevator.com

Website : www.topindiaelevator.com

Factory :

G-1127-1128, 1C Road, Lodhika G.I.D.C.
Kishan Gate, Nr. Rajendra Cold Storage,
Kalawad Road, Metoda. Rajkot - 360021
(Gujarat-India) Mobile : + 91 99241 96662

Branch Office : Bhavnagar, Surat, Junagadh, Vadodara.

સરદાર પતરા

Vardhman Industrial Zone, Plot No-15, S.V. No.-259 B/h-Kothariya Solvet,
Kothariya, Rajkot - 360002. Gujarat (India), Call : +91 87994 54774

SARDAR
ELEVATOR

AN ISO 9001:2015 COMPANY
ZMR[®]
 SOLAR ENERGY



जल है तो कल है,
ZMR पंप है तो सालो साल है

0.05 HP to 30HP
 3000 Feet Capacity



Domestic, Industrial, Agriculture, Pumps & Motors

NSIC ISO 9001:2015 CE

Manufactured By
RANJAN INDUSTRIES
 Gokul Road, 8th S.T. Bypass, Sanskar Industrial Area, Opp. Usha International, Rajkot-360024
 E-mail : ranjan24@gmail.com / E-mail : prajampa.ranjan@gmail.com
 Web : www.ranjanindustries.in
 Toll-Free No. : 1800 1234 181

AN ISO 9001:2015 COMPANY
ZMR[®]
 SOLAR ENERGY



"ऊर्जा के स्रोत को बिना नुकसान पहुंचाये ऊर्जा प्राप्त करना"



Solar Residential & Industrial Rooftop, Ground Mount Power Plant, Solar Water Pumping System

NSIC ISO 9001:2015 CE

Manufactured By
RANJAN INDUSTRIES
 Gokul Road, 8th S.T. Bypass, Sanskar Industrial Area, Opp. Usha International, Rajkot-360024
 E-mail : ranjan24@gmail.com / E-mail : prajampa.ranjan@gmail.com
 Web : www.ranjanindustries.in
 Toll-Free No. : 1800 1234 181

Mahr TOKU
 BAKER
 HEXAGON METROLOGY
 PEACOCK
 Mitutoyo



PRAMUKH INSTRUMENTATION

"MOHAN KUNJ", 2-Bhakti Nagar Station Road, Rajkot-360 002.
 Cell : 94290 49123, 75679 49798 | Email : pramukh.ins@gmail.com

LUXURIA
 Innovative Paints
 रंग तो जाहती रे...!

INDUSTRIAL CHOICE FOR
 Interior | Appliances
 Furniture | Machinery



MANUFACTURED BY
LUXURIA PAINTS

Office : Sanskar Industrial society Main Road,
 Nr, National Highway 8-B, Rajkot - 360003.
 Factory : Plot No. 40 to 44 & 55 to 57 Survey No.: 251 to 255
 Gokul Industrial Park - 2, Taluka: Kotda sangani,
 Village Piplana, Rajkot - 360024 (Gujarat) India.
 Customer Care No.: 8181981814, 909007256
 E-mail : info@luxuriapaints.com



One Stop Solution

FOR ALL KINDS OF ENGINEERING CUTTING TOOLS, TAPS, CBN/PCD INSERTS AND INDUSTRIAL LUBRICANTS



HSS-E & HSS Taps

OUR PRODUCT PORTFOLIO INCLUDES

MEBA sawing solutions.
Bimetal Bandsaw Blades
Bandsaw Blades & Circular Saw Cutters

MEBA sawing solutions.
Bandsaw Machines & Circular Saw Machines

MAGNACOO
Quality | Performance | Value
Industrial Oil
Industrial Lubricants
Industrial Cutting Oil

Member IMC Group
icent
CNC & VMC Tooling Solutions

ALFA
BIMETAL BANDSAW BLADES
M42 & M51 Grade Bandsaw Blades

JE JAY ENTERPRISE
Partners In Providing Cost Effective Solutions

📍 12/4, Bhaktinagar Station Plot, Rajkot-360 002.

☎ +91 63546 04954/ 97146 77788

✉ jay.ent.pr@gmail.com / manish@jayrjt.com

DRISHY-24



B. M. Enterprise
Partners In Journey Of Excellence

OUR PRODUCT PORTFOLIO INCLUDES

ONE STOP SOLUTION FOR ALL KINDS OF VENTILATION, COMPLETE SAWING, KNURLING, DRILLING & TAPING.



- Bandsaw Blades
- Circular Saw Cutters



- Bandsaw Blades
- Bandsaw Machines



- HSS & M35 Drills
- Center Drills & Endmils



- Bandsaw Machine
- Circular Saw Machines



- Knurling Tools
- Knurling Die



- Industrial Lubricants
- Cutting Oil

📍 "Sureshwar Nivas", 12/4, Bhaktinagar Station Plot, Rajkot -360 002
☎ +91 99257 12427, +91 63546 04954, ✉ :bmenterpriserjt@gmail.com

DRISHY-24

સરદાર પત્રા

Vardhman Industrial Zone, Plot No-15, S.V. No.-259 B/h-Kothariya Solvet, Kothariya, Rajkot - 360002. Gujarat (India), Call : +91 87994 54774





SN AUTOMATION

Manufacturing & Supplying Of

- Spring Conveyor
- Magnet Conveyor
- Hinge Belt Conveyor
- Gravity Roller Conveyor
- Scraper Belt Conveyor
- Screw Conveyor
- Truck Loading Conveyor
- Centralized Conveyor
- Mass Belt Conveyor
- PVC Belt Conveyor
- Rubber Belt Conveyor
- S.S Tank

SN AUTOMATION

Survey No 17, Plot no 3 And 4,
Behind Pentagon Forge, Gondal Road NH, Ta - Gondal,
Dist - Rajkot, AT BHARUDI, Pin-360311

Mob: 99137 39903, 99254 58848
E-mail: snautomation@lve.com,
snautomation.in@gmail.com
Web: www.snautomation.in



king
PIPES & FITTINGS
SINCE 1998

27 SAAL SE
PIPE KA KING
KING PIPES



Plumbing | Drainage | Agriculture | Sanitary

KING POLYPLAST PVT. LTD.
Opp. Taluka Seva Sadan, Rajkot-Jamnagar Old Highway,
Paddhari - 360 110, Dist. Rajkot, Gujarat (INDIA)
www.kingpipe.in | info@kingpipes.in



plasma
Nature Grows Naturally



PLASMA ALLOYS PVT. LTD

Specialized Ductile Iron Casting Foundry
With Distinctive Capabilities of
SiMo, ADI & SSFDI Grades

Address :
Plasma Gate, Plot No. 1,2,3 & 4, Revenue Survey No. 195,
Shapar - veraval, Taluka : Kotda Sangani, District : Rajkot - 360024
Email : info@plasmaalloys.com, Web : www.plasmaalloys.com
Contact : +91 97373 60666 / 82383 17777



JAY KHODAL
METAL

Mfg. of Zinc Die Casting

Product Range

- Zinc die casting
- Customized Components in zinc
- Cnc turned components in zinc
- Cnc Turned + Plating components
- Auto parts in zinc diecast components



5 - Mira Udhyog, Rajkot - 360003
+91 9998506415
info@jaykhodalmetal.com
www.jaykhodalmetal.com

ISO 9001 - 2015 | PED and AD2000 Merkblatt WO | LR Marine | IBR Approved Company



- INVESTMENT CASTINGS
- LOST WAX CASTINGS
- FEINGUSS
- MICROFUSIONES



Manufacturers & Exporters of INVESTMENT CASTING

FACTORY :

Survey No. 53, Opp. Vandheshwar Temple, N. H. No. 27, **At. HADAMTALA**,
Tal. Kotda Sangani. P.O. Box No. 32, Gondal-360 311. Dist. Rajkot. (Gujarat) India.
Cell : +91 95373 99899, +91 9712987870 (MKTG)

REG. OFF. :

Shyam Arcade, Opp. Shyam Wadi, 17/2, Station Plot, P. O. Box No. 32,
Gondal-360 311. Dist. : Rajkot. (Gujarat) India.

E - info@siddhicast.com

W - www.siddhicast.com

Enjoying joy of blending "Green Technology" with Casting...

KHODIYAR INDUSTRIAL PVT. LTD.
BELT CONVEYOR ROLLER, IDLERS & GEAR BOX

MANUFACTURER OF CONVEYOR BELT AND CONVEYOR IDLERS

Plot No. 456 to 4604, Golden Green Industrial City, Mavdi-Pal Raod,
Near Makhwad Chowk, Village-Khanbha, Tal- Lodhika, Khambha,
RAJKOT. Gujarat - 360311 (India) Mo. : **96875 67045**

info@kic.co.in | www.kic.co.in / www.kicindia.in

Aal Shree KHODIYAR ROADWAYS
(CERTIFIED COMPANY)
(ISO 9001:2015 REGISTERED CERTIFIED COMPANY)

BETTER FOR SPECIAL EXPORT CONSIGNMENT

AMD ICD
AMD AIR PORT
KANDLA PORT
MUNDRA PORT

J.N.P.T. PORT
NHAVA SHEVA
DRONAGIRI
SAHARA CARGO (ANDHERI)

CORPORATE OFFICE
Power Industrial, R.S.No-250, Plot No-38+39/2-Shed No.1,
Kothariya Solvant, Rajkot - 360022.
Contact Us:-
+91 971-425-8789 +91 957-439-9909
VISIT US at : www.askrgroup.com MAIL US at : askhodiyaaroad@gmail.com

Business Insurance



Smart way to save Tax & Take Growth on Tax

Organization that can take advantage



01 **Public Limited Company**



02 **Private Limited Company**



03 **Limited Liability Partnership**



04 **Partnership Firm**



05 **Proprietorship Firm**



06 **Trust Societies & Others**

Let's Understand

Note : The below individuals will not be considered as an employee of the organisation:

Proprietor of a proprietorship Firm | Partners in a Partnership/LLP

Contractual Employees | Trustee of a Trust

Types Of Business Insurance

■ **Keyman** ■ **Partnership Insurance**

■ **Employer - Employee**

No Impact of Budget '23 - As **Business Insurance** Remains outside the Scope of 10 - 10(d)

Premium paid is **Business expenses** under section 37(1) of Income Tax Act, 1961

Ex -gratia / compensation given to deceased employee's legal heir is tax free in the hands of family (as per CBDT Circular 573)

FIKAR
FREE Life

Contact : **Anika Sangghvi M. +91 98339 77000**

સરદાર પત્ર

Vardhman Industrial Zone, Plot No-15, S.V. No.-259 B/h-Kothariya Solvet,
Kothariya, Rajkot - 360002. Gujarat (India), Call : +91 87994 54774

SARDAR
INSURANCE

STAY SAFE, STOP SMART



BRAKE DISC & DRUM



R. M. Engineering Is The Leading Manufacturer Of Brake Discs & Drums In India For The Automotive Industry. Established In 5th - May - 2005, R. M. Engineering Has Grown Steadily To Become A Leading Brake Disc & Drums Supplier To Oems & Oess Operating In India. With Design, Development And Manufacturing Capability That Matches Global Standards In Quality And Safety, R. M. Engineering Is Capable Of Providing Full Brake Discs & Drums Technology From Concept To Completion.

**Bharat
Mobility**
GLOBAL EXPO 2025

**2025
AUT
EXPO** THE
COMPONENTS
SHOW

18th - 21st JANUARY, 2025
YASHOBHOOMI - INDIA INTERNATIONAL CONVENTION
& EXPO CENTRE (IRCC), DWARKA, NEW DELHI, INDIA

Hall No. : H1

Stall No. : D38



Manufacturer

Survey No. 201 At - Bhunava, Tal - Gondal, Rajkot - 360311, Gujarat, India.

Mo. - +91 99931 66691 | E-mail - sales@rmengineering.net

www.rmengineering.net

Ocean Infotech-Rajkot

સરદાર પતરા

Vardhman Industrial Zone, Plot No-15, S.V. No.-259 B/h-Kothariya Solvet,
Kothariya, Rajkot - 360002. Gujarat (India), Call : +91 87994 54774

SARDAR
ENGINEERING



2025 AUTO EXPO THE COMPONENTS SHOW

 18th - 21st JANUARY, 2025

YASHBHOGHE - INDIA INTERNATIONAL CONVENTION & EXPO CENTRE (IICC), DWARKA, NEW DELHI, INDIA

Hall No.: H-1

Stall No. E26



GRD[®]

 Exemplar of Best

FOR 2 & 3 WHEELERS AUTOMOBILE PRODUCTS



 MADE IN INDIA



WE PROVIDE GENUINE PARTS WORLDWIDE

Reg. Office & Works :

Gurudev Auto Industries Pvt. Ltd.

Plot No.: P-208, Road: A/10, Kranti Gate,

Metoda G.I.D.C; Rajkot - 360021, Gujarat, India.

P : +91 2827 286001 | M : +91 99248 44873

E : info@gurudevauto.com | W : www.gurudevauto.com



Classic-8327491973

સરદાર પત્રા

Vardhman Industrial Zone, Plot No-15, S.V. No.-259 B/h-Kothariya Solvet,
Kothariya, Rajkot - 360002. Gujarat (India), Call : +91 87994 54774



 SARDAR



KALAPI TRACTOR SPARES PVT. LTD.

OUR BRAND
pentech

At Kalapi, innovation and customization define every product and service, delivering tailored excellence on budget.



Our mission is to provide top-quality Tractor Parts for OEMs in varying quantities at competitive rates. Achieving this involves strategic investments in advanced infrastructure, machinery, and a skilled workforce. We believe in the strength of education, experience, and ongoing training as key pillars, with transparent business management as the foundation for efficiency and competitiveness.



Hydraulic Lift
Pump Assembly



Hydraulic Lift Pump
Assembly With
Pressure Control Unit



Hydraulic Pump
Major Repair Kit



Hydraulic Lift Pump
Control Valve



Hydraulic Lift Pump
Cam Shaft



Ram Cylinder Piston



Hydraulic Lift Selector
Valve Assembly



Hydraulic Lift
Ram Cylinder



Hydraulic Lift Draft
Control Link Assembly
with Draft Control Rod

CONTACT US:

- 📍 Rajkot, Gujarat, India.
- ☎ +91-9979898984, +91-9925444609
- 📞 +91-9016503421,
- ✉ info@kalapiauto.com, sagar@kalapiauto.com
- ✉ export@kalapiauto.com
- 🌐 www.kalapiauto.com



Hydraulic Lift Clevis
With Link Assembly

SOME OF OUR ESTEEMED CUSTOMERS ARE



સરદાર પતરા

Vardhman Industrial Zone, Plot No-15, S.V. No.-259 B/h-Kothariya Solvet,
Kothariya, Rajkot - 360002. Gujarat (India), Call : +91 87994 54774





ISK AUTO INDUSTRIES

Expert in Three Wheeler Automotive Spares



Empowered By **Innovation**



ISK AUTO INDUSTRIES

Add: Plot No. G 1933, Lodhika G.I.D.C., Almighty Gate No. 02, Road 8/1/7E, Kalawad Road, Metoda, Dist. Rajkot- 360021 (Gujarat, INDIA) | Contact Number: +91 9978691919
Email: info@iskauto.in | Website: www.iskauto.in

An ISO 9001:2015



સરદાર પત્રા

Vardhman Industrial Zone, Plot No-15, S.V. No.-259 B/h-Kothariya Solvet, Kothariya, Rajkot - 360002. Gujarat (India), Call : +91 87994 54774





- ☑ Engine Valve
- ☑ Rocker Arm
- ☑ Camshaft Assembly
- ☑ Valve Guide
- ☑ Connecting Rod
- ☑ Piston Kit

**Your trusted partner for
Precision Engine Components**

Reach Us

KAVYANT EXIM

Shop No. 10, First Floor, Trimurti Tower,
Laxmi Nagar Main Road, Opp. Shrinathji Haveli,
Rajkot - 360 004, Gujarat (INDIA).

www.kavyantexim.com | info@kavyantexim.com

Mob: +91 98795 74846



With strong commitment to excellence, innovation, and customer satisfaction, we have been a trusted partner to various industries for 30+ years.



We JRB Engineering & Company is ISO 9001 Certified Company & specializing in Valve Seat Inserts. Over the years, we've evolved and expanded our operations to become a leading manufacturer of Valve Seat Inserts in India. With a commitment to precision, innovation, and quality, we serve a diverse range of industries, including Oil & Natural Gas, Genets, Marine & Power Generation, Locomotives, High-Performance Racing, Off-Road Vehicles, Agriculture, Construction Equipment, Stationary Engines, and Heavy-Duty Commercial Vehicles.

At JRB Engineering, quality is our top priority. We are committed to delivering precision-engineered valve seats that meet the highest industry standards. Our rigorous quality control measures ensure that every valve seat undergoes thorough inspection at every stage of the manufacturing process, from raw material selection to the final product. With our unwavering commitment to quality, JRB Engineering ensures that every product we manufacture is built to perform and built to last.



**HIGH QUALITY
VALVE SEAT INSERTS
MANUFACTURER**

JRB ENGINEERING & COMPANY

Sanskar Society, Street No. 3, Sardar Chowk, 3/6 Corner, 8B Bypass Ring Road, Rajkot - 360002 (Gujarat - India)



+91 98242 80162



info@jrbengcompany.com



www.jrbengcompany.com



સરદાર પતરા

Vardhman Industrial Zone, Plot No-15, S.V. No.-259 B/h-Kothariya Solvet,
Kothariya, Rajkot - 360002. Gujarat (India), Call : +91 87994 54774



ZMZO®



SINCE 1986

Sand Molding Machine
Gravity Casting Machine
Core Shooting Machine
Casting Mold
Casting

OM ENGINEERING SOLUTION

Address: Om Engineering Solution Bhavnagar Road, Aji Vashat Rajkot - 360001
Mo. No. : Darshit Patel - +91 9824209496, **China :** +86 133 3672 1900
Email : info@pecl.co / ora@zmzogroup.com, **Web. :** www.zmzogroup.com

સરદાર પતરા

Vardhman Industrial Zone, Plot No-15, S.V. No.-259 B/h-Kothariya Solvet,
Kothariya, Rajkot - 360002. Gujarat (India), Call : +91 87994 54774

SARDAR
ENGINEERING SOLUTION



Kavya
INTERNATIONAL

Manufacturer & Exporter: **Chromed Steel Cylinder Liners**



Model:

- Chevrolet Tavera
- Isuzu 4JA1
- Isuzu 4JB1
- Isuzu 4BC1
- Isuzu 4BD1
- Isuzu 4BE1

Model:

- Isuzu 4JG2
- Isuzu 4BA1
- Isuzu 4BD1
- Isuzu 6BD1
- Isuzu 6BG1
- ACE Crane

Manufacturer & Exporter:

KAVYA INTERNATIONAL

Dhwani Industrial Area, Street No. 2, Near Kotharia Solvent Railway Crossing, Gondal High-Way, Kotharia, Rajkot-360 022 (Gujarat)
Mobile : +91 98250 64601 | E-mail : info@kavyainternational.com | Web : www.kavyainternational.com

An ISO 9001 : 2008 Certified

સરદાર પતરા

Vardhman Industrial Zone, Plot No-15, S.V. No.-259 B/h-Kothariya Solvet,
Kothariya, Rajkot - 360002. Gujarat (India), Call : +91 87994 54774





ENGINE PISTON



VALVE - GUIDE - SEAT

- AGRICULTURE ENGINES
- AIR COMPRESSORS
- 2 & 3 WHEELER VEHICLES
- PETROL & DIESELS CARS
- LIGHT COMMERCIAL VEHICLES
- TRUCKS & TRACTORS
- MARINE & EARTHMOVERS
- LOCOMOTIVE ENGINES

Playing a meaningful role in your engine



www.dipsu.in

Hall No. H1
Stand No. D36

Bharat Mobility
GLOBAL EXPO 2025

2025 **AUT EXPO** THE COMPONENTS SHOW

18th - 21st JANUARY, 2025
YASHODHAM - INDIA INTERNATIONAL CONVENTION & EXPO CENTRE (ICC), DWARKA, NEW DELHI, INDIA

www.bharatmobility.com @947731523

HIMANSHU DIESEL

C-1-B-301, Aji GIDC, Phase II, Rajkot - 360 003. INDIA

M.: +91 98795 00620, +91 99255 00062 E.: info@tusharpiston.com, himanshudiesel62@gmail.com

સરદાર પત્ર

Vardhman Industrial Zone, Plot No-15, S.V. No.-259 B/h-Kothariya Solvet,
Kothariya, Rajkot - 360002. Gujarat (India), Call : +91 87994 54774





RAJKOT ENGINEERING ASSOCIATION

DIRECTORY 2024-2025 & BULLETIN RATES

SR. NO.	ADVERTISEMENT TYPE	DIRECTORY SIZE & CM (W X H)	BULLETIN SIZE IN CM (W X H)	DIRECTORY RATE	BULLETIN RATE <small>April 24 to March 20</small>
---------	--------------------	-----------------------------	-----------------------------	----------------	--

PREMIUM SECTION

1	BACK PAGE	15 x 23	20 x 26	185000	150000
2	FIRST PAGE INNER	15 x 23	20 x 26	115000	140000
3	BACK PAGE INNER	15 x 23	20 x 26	99000	125000
4	ALL PAGE BOTTOM LINE STRIP	1 line + logo	1 line + logo	99000	80000
5	OPP. FIRST PAGE INNER	13.25 x 21	-	60000	-
6	OPP. BACK PAGE INNER	13.25 x 21	-	40000	-
7	FULL FLIP PAGE	27 x 23	37 x 26	90000	220000
8	HALF FLIP PAGE	21 x 23 + 6x23	20x26 + 10x26	60000	115000
9	POINTER FULL PAGE	13.25 x 21	-	45000	-
10	TAG - BOOKMARK	7 x 15	-	50000	-
11	PREMIUM FULL PAGE COLOR	13.25 x 21	-	35000	-
12	PREMIUM FULL PAGE + PROFILE	13.25 x 21	-	50000	-

COLOR SECTION

1	PIN PAGE (2 PAGE)	13.25 X 21	18 x 24	50000	125000
2	FULL PAGE + PROFILE	13.25 X 21	18 x 24	45000	110000
3	FULL PAGE COLOR	13.25 X 21	18 x 24	28000	75000
4	HALF PAGE COLOR	13.25 X 10.25	18 x 12	16000	40000
5	QUARTER PAGE COLOR	6.5 X 10.25	9 x 12	10000	27000

B/W SECTION

1	PIN PAGE (2 PAGE)	-	18 X 24	-	75000
2	FULL PAGE + PROFILE B/W	-	18 X 24	-	60000
3	FULL PAGE B/W	-	18 X 24	-	40000
4	HALF PAGE B/W	-	18 X 12	-	27000
5	QUARTER PAGE B/W	-	9 X 12	-	15000

બુલેટીન જાહેરાત માટેની અક્ષત્વની સુચનાઓ :

- જાહેરાત સંપર્ક માટે "ગુજરાત એન્ડ એન્ડ મીડીયા" ના મો. ૯૩૩૩૩ ૯૩૩૭૫ પર કરવાનો રહેશે.
- પેમેન્ટ "રાજકોટ એન્જીનીયરીંગ એસોસીએશન" Payable at per Rajkot નો ચેક/ડી.ડી. થી આપવાનો રહેશે.
- જાહેરાત પસંદગીની જગ્યા પહેલા તે પહેલાના ધોરણે આપવામાં આવશે.



Institute News Jan.-2025

- The monthly bulletin of Rajkot Engineering Association "Rajkot Engineering Information Bulletin" was posted to the members and other Govt.offices, Advertisers etc. on 10th December 2024 by Railway Mail Services (RMS).
- The digital Link for REA Monthly Bulletin of December-2024 was sent to members on 20-12-24.
- In response to compliant of our member M/s. Liftwell Hydraulics Pvt. Ltd, Rajkot, a letter regarding representation about frequently disruption of power supply was written to Managing Director, PGVCL, Rajkot, to take immediate proper action to maintain continuous power supply.



Task Summary

A farewell programme was arranged by Rajkot Engineering Association for the respectable Shri K.V. Mori Sir, General Manager, District Industries Centre (DIC) Rajkot, on his transfer and promotion at Vadodara.



During the programme of farewell to Shri Mori Sir, a memorable memento is being awarded to him by Rajkot Engineering Association and also by various local Association and chamber of Rajkot.





The beginning of farewell programme to Shri K.V. Mori Sir, General Manager, District Industries Centre (DIC) Rajkot, on his transfer and promotion at Vadodara, the lighting of lamp ceremony was performed by the President, Rajkot Engineering Association Shri Narendra Panchani and other Presidents of local Association are seen in the above picture.

It is needless to mention here that during the tenure of Shri K.V. Mori Sir, as a General Manager at Rajkot, has fully cooperated for the help, solution, guidance, suggestions and address to the industrial issues for the betterment and development of industrial growth of Rajkot District. And during Covid -19 Pandemic, services rendered by Shri Mori Sir is invaluable for the simplification of procedure for reopening of factories.

Concurrently a programme to welcome Shri M.K. Ladani, General Manager, DIC, Rajkot, who took place of Shri Mori Sir. On this occasion, Shri Prabhav Joshi, Collector, Rajkot District, Shri Rameshbhai Tilala, MLA of Rajkot, and the Office bearers of various local Associations were remained present.

BOARD MEETING

A Board of Directors' monthly meeting of Rajkot Engineering Association for the month of December was held on 23.12.2024 under the chairmanship of President Shri Narendra Panchani. Meeting was started with the reading of minutes of last meeting held on 28.11.2024 and other points of agenda were discussed and passed unanimously.



MSME DEFENCE CONCLAVE



"MSME DEFENCE CONCLAVE" was arranged at Rajkot Engineering Association, Rajkot, jointly organized by Rajkot Engineering Association and PHD Chamber of Commerce and industry, New Delhi, on 18.12.2024, under the theme "Technology and innovation in defence MSMEs".

In this conclave, Shri Lokesh Kumar Sharma, OSD (Defence offsets Management Wing-DOMW) Department of Defence Production, Ministry of Defence, Government of India, Dr. Nasir Jamal, Director, PHD Chamber of Commerce and industry, Shri P.N. Solanki, IEDS, Dy. Director, MSME Development and Facilitation office, Ahmedabad, and Shri Prabhav Joshi, IAS, Collector, Rajkot District were remained present and gave their speech on the subject related to conclave.

In above picture, Shri Narendra Panchani, President, Rajkot Engineering Association, lighting a lamp along with other Chief Guest and dignitaries are seen.

As the Indian Defence Industry is seeing impressive growth in the last one decade AND ONE OF THE KEY OBJECTIVES OF THE Government of India is to strengthen the defence manufacturing eco-system with extensive participation of MSMEs and Start-Ups at all levels especially in the States.



The conclave was ended with interesting discussion and deliberation on the growing opportunities for the MSMEs and Start-Ups in defence sector and also a panel discussion was held wherein Dr. Nasir Jamal (PHDCCI) , Lokesh Kumar Sharma, Shri Dhirajbhai Dudhat (Director, Rajkot Engineering Association), Shri Ravin Bhadja (Find me Factory), Shri Jayson Ganatra (Sattardas) and Shri Manish Jasani (A M Designs Pvt. Ltd.) had participated.



In above top photo expert panelists are seen discussing and replying point to point answers to various questions related to defence manufacturing in MSME sector.

In above bottom photo, Shri Lokesh Kumar Sharma, Shri Narendra Panchani and Shri P.N. Solanki are awarding a memento to Shri Prabhav Joshi, Collector, Rajkot District.



In above photo (L to R) Shri Narendra Panchani, President, Rajkot Engineering Association and Dr. Nasir Jamal, Director (PHDCC) are seen giving their valuable and insight speech during MSME Defence Conclave.





Rajkot: OEMs' Next Destination for Operational Success—The Time is Now!

The Bharat Mobility Global Expo 2025, themed “*Beyond Boundaries: Co-creating Future Automotive Value Chain*,” marks a pivotal moment for India's manufacturing sector, and Rajkot stands at the forefront of this revolution. Known as the engineering backbone of India, Rajkot is no longer just a city of traditional industries; it is now a hub of advanced manufacturing, ready to embrace and partner with global Original Equipment Manufacturers (OEMs).

Rajkot has evolved into a powerhouse of engineering excellence. Its journey from being a supplier of basic components to becoming a trusted partner in producing **engine parts, bearings, gears, intricate sub-assemblies, and machined complex parts** has positioned it as a cornerstone of India's automotive industry. The city is home to thousands of MSMEs contributing significantly to domestic and export markets, with engineering exports growing by over 15% in the past decade, as per the Engineering Export Promotion Council (EEPC).

What Makes Rajkot an Ideal Partner for OEMs? Rajkot's industrial ecosystem has witnessed remarkable advancements, creating a conducive environment for collaboration with OEMs:

- **Advanced Infrastructure:** With export-ready facilities and cutting-edge technology, Rajkot industries now offer **fully integrated ERP solutions, IoT and robotic assembly lines, high-precision tooling, and advanced automation.**
- **Skilled Workforce:** The city boasts a pool of skilled professionals in Quality Management Systems (QMS), quality control, and engineering, thanks to its numerous engineering colleges, ITIs, and private skill development centers.
- **Machine Tool Expertise:** Rajkot is home to **over 15 CNC/VMC machine tool-building companies**, ensuring that OEMs have access to sophisticated machining capabilities and innovative tools.
- **Diverse Industrial Base:** Beyond automotive, Rajkot industries cater to aerospace, defense, agriculture, and consumer goods sectors, supplying components to leading global brands.

Gone are the days when Rajkot focused solely on the spare parts market. Post-COVID, the city has shifted gears, embracing systematic workflows, global best practices, and a proactive approach to engaging with OEMs. The new generation of entrepreneurs is driving this transformation, investing in advanced manufacturing setups, in-house inspection systems, quality certifications, and automation to meet the stringent demands of global partners.

From Spare Market to OEM-Preferred Partner

Rajkot's industries have undergone a paradigm shift. Earlier hesitant to work directly with OEMs, they now actively seek partnerships to scale operations and expand market reach. With an established supply chain of **casting, forging, and machining facilities**, the city is ready to deliver finished components and sub-assemblies. Rajkot has proven its capabilities by producing parts for global automotive brands—from tractors to luxury vehicles like Mercedes—and is increasingly contributing to defense exports and the growing EV sector.



Significant strides have also been made in infrastructure. Rajkot's expanding industrial zones, improved port connectivity, government incentives, and consistent supply chains make it an attractive hub for OEMs. The city's capacity to support everything from prototyping and small-batch production to mass manufacturing ensures that OEMs can find all the solutions they need in one place.

The Rajkot Advantage

By establishing operations in Rajkot, OEMs can unlock:

- Proximity to **25,000+ CNC/VMC machines** and sophisticated machine shops.
- Cost-effective supply chains with ready to stock, **Just-In-Time (JIT)** capabilities.
- Early-mover advantage in partnering with a rapidly growing industrial base.

This is a win-win scenario where OEMs can save time, effort, and money while nurturing mutually beneficial partnerships with local MSMEs. Rajkot's industries are prepared to support the entire value chain, from new product development to assembly and testing.

Rajkot's Diversified Capabilities

Beyond automotive, Rajkot has made strides in aerospace and defense industries, providing high-precision solutions to both Indian defense units and global companies. The city is also a hub for **Textiles, Pharmaceuticals, Engineering in the field of** submersible pumps, agricultural implements, kitchenware, toys, and plastic products, showcasing its diverse industrial capabilities.

As Prime Minister Narendra Modi aptly said, *"Make in India is not just an initiative; it is a mission to transform India into a global manufacturing hub."* Rajkot embodies this vision with its openness, readiness, and preparedness to collaborate with OEMs.

The Time is Now

Rajkot is uniquely positioned to become a central hub in India's manufacturing value chain. The combination of advanced infrastructure, skilled talent, and entrepreneurial spirit makes it an ideal destination for OEMs to set up operations and final assembly lines.

Whether you're exploring **BLDC motors, Battery manufacturing, or modern EV components**, Rajkot has the potential to meet your needs. With a culture of continuous improvement, the city provides a dynamic ecosystem for innovation, scalability, and operational excellence.

As a member of the Rajkot Engineering Association and the one working closely with global OEMs, I urge you to visit Rajkot and experience firsthand the advancements the city has made. From **high-quality aerospace components to precision auto parts**, Rajkot offers capabilities that rival any industrial cluster in India.



Conclusion

Rajkot is ready to lead, not just to contribute. Together with OEMs, it is poised to redefine the future of manufacturing, innovation, and mobility in India and beyond. Don't miss the opportunity to be part of this transformative journey.

About the Author

Mr. Ravin Bhadja, Founder and CEO of RB Corporation Group of Companies, is a visionary leader in the innovation ecosystem, working with global OEMs in the automotive, aerospace, and defense sectors. Known for his out-of-the-box thinking, he has developed multiple groundbreaking products and secured global patents.

Beyond innovative product development, his platform, www.FindMeFactory.com bridges the gap between global OEMs and Indian suppliers. Through strategic partnerships, he highlights industrial hubs like Rajkot, enabling them to achieve global excellence.

Mr. Bhadja's mission is to connect OEMs with the best of India's manufacturing ecosystem, offering one-stop solutions for innovation, fast-tracking ideas to mass production, and building next-generation products at an accelerated pace.

To know more, follow him on <https://www.linkedin.com/in/ravinbhadja/>





RAJKOT ENGINEERING ASSOCIATION - AT A GLANCE

- Service to Member:-
Since the inception of Rajkot Engineering Association (1963), the very objective is to extend help to its members for promotion and development of every manufacturing activity.
- Member Categories:-
Largest Engineering Cluster in Global with 1000 plus unit members and 1500 associate members across the country of almost all segments like Agricultural equipment, Automobiles, Bearings, Bushing and spares, Diesel Engine, Electric motor and Pumps, Forging & Foundry, Machine tools etc.
- Liaison with Govt Offices:-
As the Association is having representation in all most of all State & Central Government departments viz. Central Excise, Income Tax, DGFT, ESIC, NSIC, MSME, DIC, BIS, VAT, GPCB, PGVCL, etc. hence if members have any problems, it could be solved amicably through the grievance redressal system.
- Testing and Research Facilities:-
Association has established a Common Facility Centre (CFC) named RAJKOT ENGINEERING TESTING & RESEARCH CENTRE with the help of Ministry of MSME, govt. of India, and Govt. of Gujarat to serve Submersible Pump & Electric motors' segment.
- Affiliation with Associations:
REA is affiliated to nationwide institutions like CII, ACMA, EEPC, IIF etc.



FOUNDRY CHEMICALS



FEEDCHEM

MANUFACTURERS OF FOUNDRY CHEMICALS & COATINGS

Our Products

- ▶ No Bake Binder Systems
- ▶ Refractory Coatings in Solvent & Water
- ▶ Green Sand Mould Additives
- ▶ Auxiliaries

FEEDCHEM (INDIA) PVT. LTD.

 Plot No. 28 to 38, "Gokul Industrial-C"
Survey No.234 and 256, J K Industrial Zone,
Village - Piplana, Rajkot-360024, (Gujarat-INDIA)

 info@feedchem.co.in
www.feedchem.in

 +91 81400 03456



Chirag Shah
098240 28131

We are Dealing In :

IPA (ISO PROPYL ALCOHOL)
AEROSOL OT (DI OCTYL SODIUM
SULHOSUCCNATE)
1 OCTANOL
MEK (METYL ETHYL KETON)
PETROLIUM JILLY
2 ETHYL HEXNOL
LABORATORY CHEMICALS N GLASS WEAR
GLASS PARTS OF CARBON SULPHUR
APPRATUS N CONSUMABLE

**BHUMI
SCIENTIFIC INC**

Reg. Office : A/7, Sumel Flats, Nr. Shreyash Crossing,
Ambawadi, Ahmedabad - 380015 INDIA

Office : C-27, Maruti Ind. Estate, Opp. Kirti Tools,
Ph 1, GIDC Vatva, Ahmedabad - 382445 INDIA



We Shape Your Imaginations

We Deliver Results that exceed our client's expectations and we are committed to providing the highest level of customer service

Our Services

Precision Patterns For Foundries
Custom Patterns
Designing
Machining
Casting
Reverse Engineering

We Working for

Valves and Pumps
Machine Tools
Textiles
Marine Parts
Automotive

Pattern Material

Wood
Aluminium
Thermocol

Prasad PATTERN WORKS

info@prasadpattern.com
prasadpatternworks@gmail.com
www.prasadpattern.com

17-Ashapura Nagar, Kothariya Road, Rajkot 2.

Chandresh Bakraniya +91 97142 02314



All Type of
**CI&SGICasting
Manufacturing**

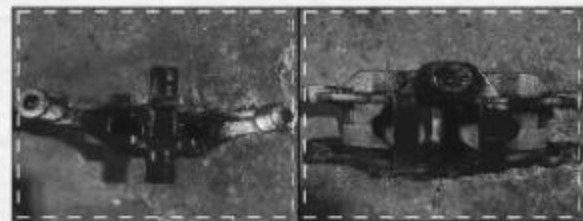

Address : JK Diamond Industrial Area, Survey No.123,
Plot No. 56/57/58, Lohada, Rajkot, Gujarat - 360002
Phone No. +91 94272 20481 | + 91 97500 10017
Email : shivmetal123@hotmail.com



Paresh Rangani
+91 82645 57951



STEEL
ALLOY STEEL
CASTING PARTS

NEON ENTERPRISE

Address : Mani Nagar-3, Nr. Ashok Garden,
Mavdi plot, Rajkot - 360004.

Email : neonenterprise93@yahoo.com



MAA Quality Inspection Services

- **Competent Person under Factory Act**
Inspection of Hoist and Lifts and Certification in Form No: 09 – LIFT INSPECTION CERTIFICATION
- **Inspection of Lifting Tools and Tackles Certification in Form No: 10 – CHAIN BLOCKS, D SHAKLES, ALL TYPES OF CRANES – EOT, HYDRAULIC MOBILE CRANE, CRAWLER, TOWER CRANE, GANTRY CRANE, HYDRA, FORK LIFT, EYE BOLT, SLING, ELECT HOIST, STACKER, FORK LIFT, WINCH, PLATE CLAMP, MONORAIL, HOOK CHOOK,**
- **Inspection external & internal examination & hydraulic testing of pressure vessels/plants etc and Certification in Form No: 11 – AIR RECEIVER, REACTOR, OIL EXPELLER, PRESSURE VESSEL.**
- **Inspection for Safety against rotating/moving machinery, power presses, Centrifugal Machines, Dangerous Machines and Certification – POWER PRESS, CENTRIFUGAL MACHINE**
- **Inspection of Dust/Fume Extraction/Ventilation System, Dangerous Process, exposure of workman etc. and Certification in Form No: 28A – FOUNDRY PLANT, PAINT SHOP**
 - Chartered Engineer Certification
 - Govt Approved Valuer- Plant and Machinery
 - DISH Approved Safety Training as per requirement
 - Legal Safety Audit as per IS 14489:2018
 - NDT Witness – UT,MP,T,RT,LPT
 - Third Party Inspection
 - Thickness mapping of Pipe Line, Vessel, Tank
 - Noise Level and Illumination Level Measurements
 - IMS Co ordination

Address : G21, Unity Plus, Opposite Suvama Bhumi Complex,
Nana Mova Main Road, Behind Speedwell Party Plot, Rajkot - 360005
Email : mjis.rajkot@gmail.com Mobile No. : 94279 64701 | 90818 85344

હિરેન ધારૈયા

CNC પ્રોગ્રામિંગ ક્લાસિક્સ

હાર્દિક ધારૈયા

95742 61002

CNC

પ્રોગ્રામિંગ શીખો

CNC મશીન ઉપર પ્રેક્ટીકલ સાથે

ISO
પ્રમાણિત
સંસ્થા



Centrifugal Mono-block Pump,
Open-well Pumps,
V4/V6 Submersible Pump-sets,
Self Priming Pumps &
Electric Motors.



Plot No. 150, Dindayal Ind. Estate, Opp. Gamara Hotel,
N.H.8-B, Aji Vasahat, Rajkot-360 003.
Cell : +91 97277 33357, +91 97277 33358
Email: loyalpump@gmail.com Visit us: www.loyalpump.com

સરદાર પતરા

Vardhman Industrial Zone, Plot No-15, S.V. No.-259 B/h-Kothariya Solvet,
Kothariya, Rajkot - 360002. Gujarat (India), Call : +91 87994 54774





RK[®]
AUTO SPARES



SHALIMAR
Engineering Works

Manu. : All Type of Engine Auto Valve

6, Atika Ind. Area, Dhebar Road (South),
Nr. Khodiyar Garage, Rajkot-360002
Mobile : 9879991005
Email : shalimaraautospare@gmail.com

Arun[®]
PUMP

**Smart and Reliable
Solar-Powered
Pumping Solutions**

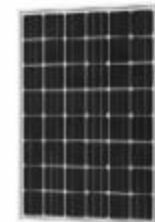

AMAL PUMP LLP
Mfg. Submersible Pump & Openwell
Plot No. 302, S.S. To. A.P. Ind. Estate, Gandhinagar,
Tal. Gandhinagar, Dist. Gandhinagar, Gujarat
www.amalpump.com

Hardik Patel
+91 74055 73555

info@amalpump.com
www.amalpump.com

Jay Chirag[®]
SUBMERSIBLE PUMP SET

MADE IN INDIA

V-3, V-4, V-5, V6,
Submersible &
Openwell Pump Set



Mfg. By:
Chirag Industries

Jay Sagar Industrial Estate, Tal. - 360003 (Gujarat) India.
Tel: +91 281 2304039
Email: info@chiragpumps.com
www.chiragpumps.com



GREENSTONE[®]

**A Next Generation Product
Green Building Solution**

Fly-Ash Bricks
Plant



**Low Investment
Quick Returns**

Light Weight Blocks Made Easy
CLC Plant



Paver Block Plant
CLC Block Plant
Precast wall Plant
Precast Mold
Pre-Mix mortar plant
All kind of Mixer

HEM CARE CORPORATION

Manufacturers & Exporters all kind of Eng. Goods.

Off. /Fac. : G/1505, G.I.D.C., Opp. Telephone Exchange, At. Metoda, Ta. Lodhika, Rajkot (Guj.) INDIA
Phone: +91 94269 96888, 094262 01058 E-mail: hemcare@gmail.com

www.hemcarecorporation.com

સરદાર પતરા

Vardhman Industrial Zone, Plot No-15, S.V. No.-259 B/h-Kothariya Solvet,
Kothariya, Rajkot - 360002. Gujarat (India), Call : +91 87994 54774





ACTIVITIES OF RAJKOT ENGINEERING ASSOCIATION (REA)

- **Infrastructure facilities: -**
REA is having state-of-the arts **Infrastructure facilities** like theatrical fully A.C. auditorium having 330 seating capacity with big LED Screen with size of 6 X 9.5 feet which is first of its kind in local auditorium. Also, a Board room and Conference room having 50 seating capacity with Video Conferencing facility.
- **Medical facilities: -**
REA has made a special arrangement to provide **medical facilities** to the members and their family members to get discounted rate OPD, IPD, Surgery etc. treatment with renowned multi specialties hospitals of Rajkot like, Synergy Hospital, Shree Giriraj Hospital, Netradeep Eye hospitals. Also, a twice in a month a Medical Van of Labor welfare Board of State Govt. is visiting to REA for free medical check up of labor / employees of industries.
- **Activities of Seminar, awareness, training programmes :-**
REA is arranging periodically and need base Seminar, awareness, training programmes etc. for updating and upgrading knowledge of members for various subject like industrial, export polies etc.
- **Raw material Assistance to Members: -**
REA is providing raw material like Pig iron to its members on **no loss no profit basis**.
- **Export Certification Facility:-**
REA is authorized to issue **Certificate of Origin (NP)** by the DGFT, New Delhi, to the exporter members.
- **Visa Recommendation Facility: -**
REA is issuing recommendation letter for issuance of **Visa** to various foreign embassy for the members.
- **Liaison with Govt:-**
Along with other activities, being a social responsibility, a sister concern of REA, named **RAJKOT ENGINEERING ASSOCIATION CHARITABLE TURST** is helping hand to society at the time of natural calamities like, earthquake, flood, by supply of food, donation etc.
- **Publication of information: -**
Monthly **Informative Bulletin** for members and biennially **Members Directory** publishes for members. These literatures are prepared with the aim of making the market easy for the members.
- **Participation in international Trade fair / exhibition.**
A delegation of REA members is periodically participating in international trade/exhibition with the support of International Cooperation scheme of MSME, Govt. of India and getting valuable export orders and also forex for the country. Recently, 20 members have visited KOREA METAL WEEK, at South Korea.



KRISHNA METAL CAST

We offer a full comprehensive service to single bespoke or full production aluminium castings & patterns.

Since 1996

- o Annual production capacity: **700 tons**.
- o Our foundry is capable of producing castings which exceed **2 tonnes** in mass and **2.5 meters** in length.
- o In the case of large parts and small lots (**up to 5,000 pieces per year**), we utilize **No Bake sand molds**.
- o In contrast, for large production runs (**over 5,000 pieces per year**) of castings weighing up to **40 kg**, we employ die casting techniques.
- o We offer one-stop solutions for all **ferrous and non-ferrous** metal parts, as well as **forging, plastic, and polystyrene parts**.

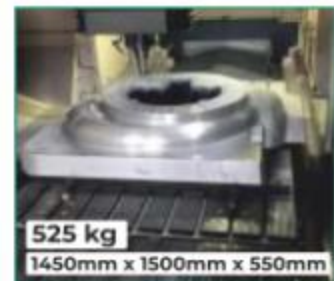
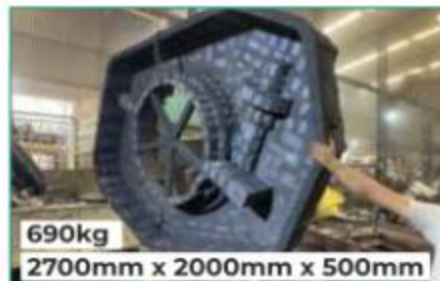
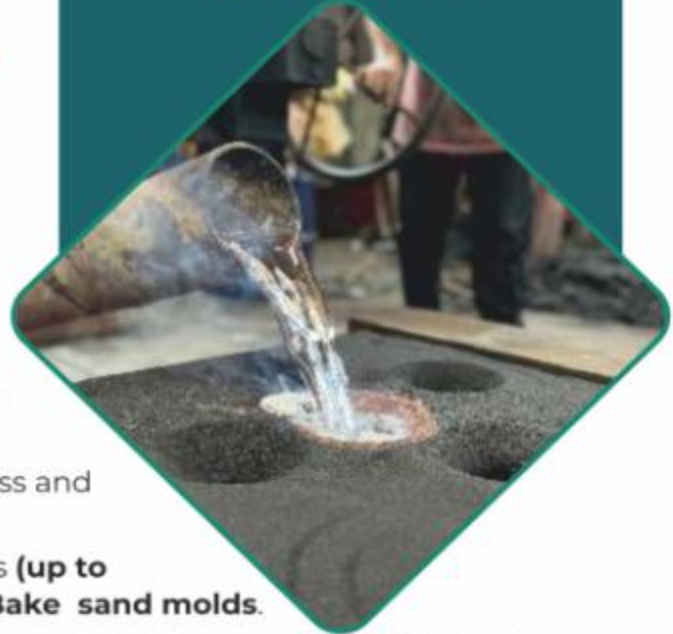

Krishna Metal Cast

📍 Rani Industrial Area, B/h Parin Furniture, Gondal Road Highway, Vavdi, Rajkot - 360005, (Guj., India)

☎ +91 99799 09845 📠 +91 95125 00888

✉ krishnametalcastllp@gmail.com 🌐 www.krishnametalcast.com

સરદાર પતરા

Vardhman Industrial Zone, Plot No-15, S.V. No.-259 B/h-Kothariya Solvet, Kothariya, Rajkot - 360002. Gujarat (India), Call : +91 87994 54774

SARDAR
Engineering & Technology

28
Year in Business
Since 1997

Driven by
Quality, Performance
& Excellence

**Unwavering Reliability,
Engineered for Performance.**



Mfrs. & Exporter of CV Components



R. E. Components Pvt. Ltd.

An IATF 16949 & ISO 9001:2015 Certified Company

📍 1206, G.I.D.C. Lodhika, Gate No.2, Road-H, Metoda. Rajkot 360 021 (Gujarat) INDIA.

☎ +91 2827 297950 ✉ sales@recpl.co.in | marketing@recpl.co.in 🌐 www.recpl.co.in

સરદાર પત્ર

Vardhman Industrial Zone, Plot No-15, S.V. No.-259 B/h-Kothariya Solvet,
Kothariya, Rajkot - 360002. Gujarat (India), Call : +91 87994 54774



MANUFACTURER OF AUTOMOBILE ENGINE PARTS



"THE AGE OF EXPERIENCE"

the heart
of every
engine



**CONNECTING
ROD KIT**



**CAM SHAFT
ASSLY**



**VALVES
GUIDE**



VALVES



ROCKER

STEEL TECH INDUSTRIES

Plot No. 27, Urja Industrial Park, Near Bharat Orni, Shapar (Veraval), Dist. : Rajkot - 360 024 (Gujarat) INDIA.
Mo. 99799 29309 / 7878939878 / 98242 13449
steeltechind@yahoo.com www.suncrankparts.com

સરદાર પતરા

Vardhman Industrial Zone, Plot No-15, S.V. No.-259 B/h-Kothariya Solvet,
Kothariya, Rajkot - 360002. Gujarat (India), Call : +91 87994 54774





Perfect Choice For the Customers



Engine Valve | Valve Guide | Camshaft Assembly | Rocker Arm | Connecting Rod Assembly | Piston Kit

MANUFACTURE & EXPORTER

1/4 Mavdi Plot, Radiya Estate, Plot No. 10,
Old Kishore Oil Mill, Rajkot - 360 004 GUJARAT (INDIA)
Cell : +91 98250 74846, 98795 74846
E : satyamauto@gmail.com

www.satyamauto.com



AN ISO 9001 : 2015 CERTIFIED COMPANY



GLOBAL LINERS
MANUFACTURER AND EXPORTER



Best Quality
Best Rates



Manufacturer of Centrifugal Cast Cylinder Liners, Sleeves & Blocks

SR No. 147 & 148, Plot No. 4/1 & 4/2,
Siroya Industries Area, Kotda Sangani Road, Rajapara,
Rajkot - 360030, Gujarat (India)

Call: +91 9904406404
sales@globalautoliners.com
www.globalautoliners.com

સરદાર પત્રા

Vardhman Industrial Zone, Plot No-15, S.V. No.-259 B/h-Kothariya Solvet,
Kothariya, Rajkot - 360002. Gujarat (India), Call : +91 87994 54774



**Quality
Always Reflects...**



AUTOFIELD WATER PUMP

We provide a wide range of Water Pumps to suit any Cars, Tractors, Trucks & Earth Movers...

Maruti Suzuki, Hyundai, Toyota
Ford, Tata, Renault, Nissan
Volkswagen, Chevrolet, Mitsubishi
BMW, Audi, Mercedes, Jaguar
Mahindra, Messy Ferguson & JCB...

**Bharat
Mobility**
GLOBAL EXPO 2025

2025 AUF EXPO THE COMPONENTS SHOW
18th - 21st JANUARY, 2025
YASHBOHOMI - INDIA INTERNATIONAL CONVENTION & EXPO CENTRE (IICC), DWARKA, NEW DELHI, INDIA

**Hall No. H1
Stand No. D32**



Autofield India

1/4 Mavadi Plot, Plot No. 8, Old Kishore Oil Mill, Radiya Estate, Rajkot (Gujarat) India.
M +91-9824200058 | E autofieldindia@hotmail.com | info@autofieldindia.com

www.autofieldindia.com

autofieldindia.com | 942723328

સરદાર પતરા

Vardhman Industrial Zone, Plot No-15, S.V. No.-259 B/h-Kothariya Solvet,
Kothariya, Rajkot - 360002. Gujarat (India), Call : +91 87994 54774

SARDAR
INDIA

Since 2009



Quality is our Success...

MFG. : AUTO PARTS
2, 3 & 4 WHEELER

Genuine Parts **Genuine** **Performance**

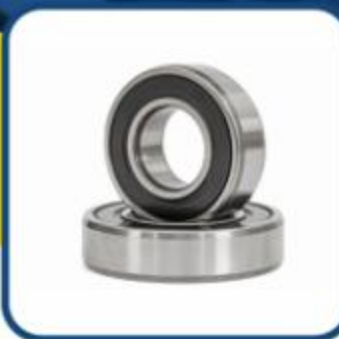

NILKANTH INDUSTRIES

Harbhole Industries - B, Nr, Robot Pump,
B.H Power Ind. Kothariya, Solvant,
Rajkot (Guj.) India.

MADE IN INDIA

✉ nilkanthautocam@gmail.com
🌐 www.nilkanthautocam.com
☎ +91 94294 01563

સરદાર પત્ર

Vardhman Industrial Zone, Plot No-15, S.V. No.-259 B/h-Kothariya Solvet,
Kothariya, Rajkot - 360002. Gujarat (India), Call : +91 87994 54774





CKR ENGINEERING PVT LTD

Manufacturer & Exporter of Automobile & Earthmoving Parts



Hydraulic Lift
Pump Assembly



Hydraulic Lift Pump
Assembly with
Pressure Control Unit



Hydraulic Pump
Major Repair Kit



Hydraulic Lift Pump
Control Valve



Hydraulic Lift Pump
Cam Shaft



Hydraulic Lift Selector
Valve Assembly

**Bharat
Mobility**
GLOBAL EXPO 2025

2025 AUF EXPO THE COMPONENTS SHOW
18th - 21st JANUARY, 2025
YASHOBHOOMI - INDIA INTERNATIONAL CONVENTION
& EXPO CENTRE (IICC), DWARKA, NEW DELHI, INDIA

Hall No. H1
Stand No. E27

for more detail contact us:

CKR ENGINEERING PVT. LTD.

Survey No. 26, Plot No. 13, B/h. Kaneriya Oil Ind.,
Near Galaxy Technoforge, Shapar (Veraval) 360 024, Dist. Rajkot (Gujarat) INDIA

+91 8866 222201 info@ckrengg.com www.ckrengg.com

● RCS: 18600 00023

સરદાર પતરા

Vardhman Industrial Zone, Plot No-15, S.V. No.-259 B/h-Kothariya Solvet,
Kothariya, Rajkot - 360002. Gujarat (India), Call : +91 87994 54774

SARDAR
INDIA

“Quality is our
FORTE”

VISIT US

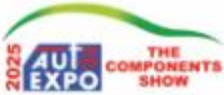

18 - 21 JANUARY 2025
Yashobhoomi, Dwarka,
New Delhi

HALL - H1
BOOTH - F20



Our Quality Products

Truck Hub Units | Repair Insert Units | Tapered Roller Bearings



Galaxy Bearings Limited

An ISO/TS 16949, ISO 14001 & BS OHSAS 18001 Certified Company

Survey no. 253, National Highway no. 27, Village : Shapar,
Dist : Rajkot - 360024, Gujarat, INDIA.

Ph. : +91- 2827 - 252401 / 02 | Fax : +91- 2827 - 252400

Email : info@galaxybearings.com | Web : www.galaxybearings.com

સરદાર પત્ર

Vardhman Industrial Zone, Plot No-15, S.V. No.-259 B/h-Kothariya Solvet,
Kothariya, Rajkot - 360002. Gujarat (India), Call : +91 87994 54774





Cast iron rotors



Cast iron rotors and drums



Cast iron engine



Cast iron drums



Ductile iron pipes



Cast iron 5-25 kgs



Cast iron 25-70 kgs



Cast iron broken Machinery



Cast iron chips



M S profile cutting scrap



M S plate cutting scrap



M S fish cutting scrap



M S angle cutting scrap



Busheling scrap



CRC busheling bales



Seamless & welded pipes



Alloy Steel Scrap



Secondary M S plates



FINE TRADE LINK

CAST IRON SCRAP | MS SCRAP | MS PIPES | PROFILE PLATES | PRIME PLATES

📍 10th Floor, Office No.10, Victoria Bliss, Opp. Victoria Park, Iscon Mega City, Bhavnagar-364001 (Gujarat) India

☎ +91-8141 464 646 / +91-9979 140 000 📞 +91-278-2421414 / 2421412

✉ info@finetradelink.com 📧 finetradelink@yahoo.com 🌐 www.finetradelink.com

સરદાર પતરા

Vardhman Industrial Zone, Plot No-15, S.V. No.-259 B/h-Kothariya Solvet,
Kothariya, Rajkot - 360002. Gujarat (India), Call : +91 87994 54774





RAJKOT ENGINEERING ASSOCIATION

REANA સભ્યોની સવલત અંગેની ઉપલબ્ધતાઓ

૧. એક્સપોર્ટર માટે સર્ટીફિકેટ ઓફ ઓરીજન ચાર્જ રૂ. ૧૩૦/- પ્રતિ સર્ટીફિકેટની સવલત.
૨. ઓડિટરીયમની સવલતો
 - A.C. કોન્ફરન્સ રૂમ ૫૦ ની બેઠક સાથે.
 - A.C. બોર્ડ રૂમ ૫૦ ની બેઠક સાથે.
 - A.C. ઓડિટરીયમ ૩૩૦ ની બેઠક સાથે.
 - LED TV / અલ્ટ્રા મોડર્ન સાઉન્ડ સીસ્ટમ, મોટોરાઈઝ્ડ સ્ક્રીન, પ્રોજેક્ટર તથા લેપટોપ સાથેની સવલત.
૩. વિડીયો કોન્ફરન્સીંગ ફેસેલીટી જેમાં ૨૫ સીટીંગ કેપેસિટીની સવલત.
૪. લાયબ્રેરી : ટેકનિકલ, નોન ટેકનિકલ બુક્સ સાથેની અદ્યતન સુવિધા સાથેની લાયબ્રેરી.

ભક્તિનગર ઇન્ડ. એસ્ટેટ જી.આ.ડી.સી.,

શેરી નં.-૩, રાજકોટ.

Mo. 99132 14935 / Email : info@reaindia.com



સરદાર પત્ર

Vardhman Industrial Zone, Plot No-15, S.V. No.-259 B/h-Kothariya Solvet,
Kothariya, Rajkot - 360002. Gujarat (India), Call : +91 87994 54774

SARDAR
KOTHARIYA SOLVET



Manufactures :
 CNC, PLC Hydraulic, Internal, External & SPM
Grinding Machine,
 For Production & Tool Room



CNC Cylindrical Grinding Machine
 2000 mm



Cylindrical Grinding Machine
 150 x 300 mm

श्री BUTHAVANI
MECHANIC WORKS

J.P. Marg, Street No. 1 Dudhrej Road, Surendranagar - 363 001. Gujarat, India.
 Mobile : 09925004333, 09825223885 | Email : bmwswasticgrinders@gmail.com
www.swasticgrinders.com



An ISO 9001:2015 Company



- 40 | Feet Head Per Stage in V-5 Pump
- 45 | Feet Head Per Stage in V-6 Pump
- 50 | Feet Head Per Stage in V-6 Pump
- 70 | Feet Head Per Stage in V-6 Pump
- CED | Coating On All Casting Parts

Mfg.: V-3, V-4, V-5, V-6 & Openwell
 Submersible Pumps

Manufactured By:
ACTIVA PUMPS

Somnath Ind. Area, In Side Kothariya Railway Crossing, Opp. Krishana Park
 Hotel, Gondal Highway, Rajkot. (Guj.) Mo. +91 98257 23323
 ✉ activapumps@gmail.com 🌐 www.activapumps.in

સરદાર પતરા

Vardhman Industrial Zone, Plot No-15, S.V. No.-259 B/h-Kothariya Solvet,
 Kothariya, Rajkot - 360002. Gujarat (India), Call : +91 87994 54774





SINCE 1963

Fieldmarshal

Marshalling Green Fields

MILLIONS OF SATISFIED CUSTOMERS WORLDWIDE



FMA 12 and FMW 14 Engines



PMT 15 and PMT 18 Engines



Bore well Submersible Pumps



C/PVC, UPVC, SWR and AGR Pipes & Fittings



Lister Engines



High Speed Diesel Engines and Pump Sets



Mini Manoblock Pumps



55 Open well Submersible Pumps



Induction Motor



Centrifugal Manoblock Pumps



Alternators



C Body Open Well Submersible Pumps



Mini Manoblock Pumps



P. M. DIESELS PVT. LTD., ARVIND INDUSTRIES, P.O. BOX NO. 1003, AJI INDUSTRIAL ESTATE, RAJKOT - 360003 (GUJRAT - INDIA) Phone: +91-9106882861 Fax: +91-9023550564 Email: contactus@fieldmarshal.com



સરદાર પત્ર

Vardhman Industrial Zone, Plot No-15, S.V. No.-259 B/h-Kothariya Solvet, Kothariya, Rajkot - 360002. Gujarat (India), Call : +91 87994 54774



Discover THE WORLD WITH US



Unlock Exclusive Our Services

- ✦ FLIGHT BOOKING
- ✦ CRUISE BOOKING
- ✦ HOTEL BOOKING
- ✦ DOMESTIC & INTERNATIONAL TOUR PACKAGES
- ✦ MICE & CORPORATE TOURS
- ✦ CHARTER FLIGHT BOOKING
- ✦ EURO RAIL BOOKING
- ✦ PASSPORT ASSISTANCE
- ✦ USA & CANADA PASSPORT RENEWAL
- ✦ VISA SERVICE
- ✦ CANADA PR PROCESS
- ✦ ATTESTATION / APOSTILLE SERVICE
- ✦ TRANSLATION SERVICE



ASSOCIATE WITH



102 - Balaji Square, Sarveshwar Chowk,
Yagnik Road, Rajkot - 360001

099240 77731 / 099248 77731

www.royaltourstravels.com
royaltourstravels@gmail.com



Our Machines, Ranging From 40KW To 100KW, Are Engineered To Meet The Demands Of Modern Industry, Offering Unmatched Precision, Reliability, And Efficiency

SPECIAL APPLICATION OF OUR PRODUCT



STRIP HEATING



INDUCTION BRAZING

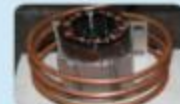

SHRINK FITTING



INDUCTION HEATING



INDUCTION ANNEALING



WWW.SHAPET.IN

SHAPET INDUCTION PVT. LTD.

Gate No. 1, Plot No.-2605/A, Rd Number 11, GIDC Metoda,
Near Silver Techno cast, Metoda-360021. Gujarat (India)

+91 98794 61162 / +91 98253 69897

Sale@shapet.com

OUR PRESENT IN ABROAD

- UAE (Dubai)
- USA
- MALAYSIA
- SINGAPORE
- AUSTRALIA
- BANGLADESH
- ITALY
- NEPAL
- OMAN
- SAUDI ARABIA
- TANZANIA
- SRI LANKA

સરદાર પત્ર

Vardhman Industrial Zone, Plot No-15, S.V. No.-259 B/h-Kothariya Solvet,
Kothariya, Rajkot - 360002. Gujarat (India), Call : +91 87994 54774



REVOLUTIONIZING GRINDING SOLUTIONS

KIYA



EG Series
CNC External Cylindrical Grinders

HCG Series
Hydraulic Cylindrical Grinders

CL 100
Hydraulic Centerless Grinder

IG 30
CNC Internal Cylindrical Grinder

GRINDING SOLUTIONS

- CNC External Cylindrical & Track Grinder
- CNC Internal Cylindrical & Track Grinder
- CNC Centerless Plunge Grinder
- CNC LIP Grinder
- Horizontal Spindle Rotary Table Surface Grinder
- External Cylindrical Grinder
- Internal Cylindrical Grinder
- Centerless Grinder
- Special Purpose Grinder

ABOUT US

KIYA PRODUCTS PRIVATE LIMITED is a rajkot based manufacturer of precision grinding machines under the brand name "KIYA" with a legacy of more than 3 decades of its heritage. To accommodate our growing business "Ignite Inc" formerly known as Champkraft Machine Tools under the brand name "Solco Grinders" with a legacy of over 35+ years in grinding machines is now moved to Rajkot with a better infrastructure, quality, and a new range of grinding machines. Kiya portrays its extensive expertise in manufacturing various grinding machines meeting the customer's prospects and expectations in terms of quality, precision, productivity & reliability.

KIYA

Kiya Products Private Limited

Plot No. G-1925, Gate-2 (Almighty Gate), Kalawad Road,
Lodhika GIDC, Vill- Metoda, Dist- Rajkot 360 021, Gujarat, India.
E info@kiyaproducts.com M +91 99789 61509

Sales | sales@kiyaproducts.com, +91 93281 61506,
Service | service@kiyaproducts.com, +91 99781 61507

kiyaproducts.com

સરદાર પત્રા

Vardhman Industrial Zone, Plot No-15, S.V. No.-259 B/h-Kothariya Solvet,
Kothariya, Rajkot - 360002. Gujarat (India), Call : +91 87994 54774

SARDAR
KOTHIYAS

Fly Your Dreams...
BEST[®]
 TOURS & FOREX Pvt. Ltd.
 SINCE: 1996

ગુજરાતી મહારાજ સાથે

યુરોપ તથા અન્ય દેશોના ગ્રુપ પ્રવાસો

2025ની સ્કીમનો લાભ લેવા સંપર્ક કરો



EUROPE



VIETNAM



TURKEY



SCANDINAVIA



SOUTH AFRICA



SPAIN & PORTUGAL



CANADA WITH CRUISE

📍 RAJKOT
 ☎ +91 80005 00050
 📍 AHMEDABAD
 ☎ +91 81005 00050



સરદાર પતરા

Vardhman Industrial Zone, Plot No-15, S.V. No.-259 B/h-Kothariya Solvet,
 Kothariya, Rajkot - 360002. Gujarat (India), Call : +91 87994 54774

SARDAR
 TOURS & FOREX

Sagar Parsana
+91 98795 86565

Bansi Parsana
+91 96876 10910



**Mfgr. of all kinds of Precision Graded
C.I. Casting. Ranges from 1 kg. to 15 Ton**

2-Sanskar Society, Near Khokhad Dadi River,
National Highway-27, Rajkot - 360 002.

info.krunalmanu@gmail.com

સરદાર પતરા

Vardhman Industrial Zone, Plot No-15, S.V. No.-259 B/h-Kothariya Solvet,
Kothariya, Rajkot - 360002. Gujarat (India), Call : +91 87994 54774



Shailesh
SINCE 1970

TWO COLUMN WIDE BED PRESS

HYDRAULIC SHEARING MACHINE
HYDRAULIC PRESSBRAKE MACHINE
TWO COLUMN WIDE BED PRESS MACHINE
TWO COLUMN PRESS MACHINE

MANUFACTURED & EXPORTED BY
SHAILESH GROUP OF COMPANIES

Shailsh
Vivo
Deviana

2/10 (NEW 20), Shaktinagar, Station Plot Rajkot - 360 002, Gujarat - India
Email: info@shaileshmachines.com | 3602 - www.shaileshmachines.com & www.looshyvivo.com

IPESH
Since 1979

MANUFACTURE OF
HYDRAULIC
THREAD ROLLING MACHINE.

Golden Client

PERFECT
MACHINERY

FINE THREAD FORM INDUSTRIES

Hydraulic Thread Rolling Machine Model D1 25mm
Hydraulic Thread Rolling Machine Model D1 40mm

Plot No. G-2052/A, Near Shree Ram Hospital, Kishan Gate, Kalawad Road, Metoda GIDC, Rajkot (Gujarat - India).
Ph. 02827 - 286032, Mo. 99799 09032 / 99138 55204 / 73821 02032
E-mail: info@dipeshindustries.in | dipeshakwana5@gmail.com
Web: www.dipeshindustries.in

SCM SHREE CHAMUNDA METALS

Our Expertise

Tractor Sheet Metal Parts.
Rotavator Sheet Metal Parts.
All Type Of Sheet Metal Works.
Deep Draw Works.

SHREE CHAMUNDA METALS

Address : 149/A Meera Udhayog, Street no. 8, Nr. Banshidhar Weigh Bridge, Aji Vasahat, Rajkot - 360003.
Call : 90333 38040 | 90993 78497

ONE STOP SHOWROOM FOR HOSPITAL & HEALTHCARE PRODUCTS.

AN ISO 9001 : 2008 & ISO 13485 : 2015 AC 2012, CE, FDA & GMP CERTIFIED COMPANY

WESTERN SURGICAL EQUIPMENTS PRIVATE LIMITED

We are Available on : GeM

OUR CORPORATE OFFICE

"Happy Home", 1st Floor, 23, Karampara, B/R, S.T. Bus Stand, Kanak Road, Rajkot-360 001. Ph. : +91 201-2232871/2243159
Mo. : +91 98250 89000 - +91 98250 45007
Email : westernsurgical@gmail.com
www.westernsurgical.in

OUR MANUFACTURING UNIT

7-Dhawan Industrial Estate, Nr. Kothariya Railway Crossing, B/h. Jay Ganesh Ford Service Center, NH-48, Gondal Road, Nr. Neera Papad, Rajkot-360 907, Gujarat (India).
M. : +91-94280 83751



DRILLS, ENDMILLS, REAMERS, THREADMILLS & CUSTOMIZED TOOLS

Manufacturing & Re Conditioning
of Solid Carbide Round Tools

OPPORTUNITY FOR SOLID CARBIDE TOOLS!



MANUFACTURER OF SOLID CARBIDE TOOLS

59 - A, Maruti Industrial Estate, B/h. Ashish Engineering Works, Outside,
Octroi Post, Gondal Road, Rajkot - 360004, Gujarat (INDIA).

info@smoothtools.in | www.smoothtools.in | +91 99131 01111, +91 99786 99789

Follow Us On :



Nailless Plywood Box
Plywood Pallet
Pinewood Pallet
Pinewood Box

Nailless Box are
Manufactured with
German Technology.

JAGTAT WOOD PACKSAFE

Plot No.-1 & 2/3, Survey No. 289,
Vill. New Haripar (Taravada), Tal. Lodhika,
Dist. Rajkot - 360 004. Gujarat, India.
+91-99250 19190 | +91-94088 61715
jagtat.wps@gmail.com | www.jagtatnaillessbox.com



JAGTAT
we protect your product



સરદાર પતરા

Vardhman Industrial Zone, Plot No-15, S.V. No.-259 B/h-Kothariya Solvet,
Kothariya, Rajkot - 360002. Gujarat (India), Call : +91 87994 54774



Jagdish®

Submersible Pumps



JAGDISH ENGINEERING INDUSTRIES
RAJKOT (GUJARAT)
MOBILE : 70418 87873 / 70418 87879

Addison®

The Safe Connection
ELECTRIC WIRES & CABLES



PRODUCT RANGE :-

- FR & FR-LSH House Wires
- Submersible Flat Cables
- Industrial Cables
- Multi core Flexible Cables
- Aluminium Cables
- LT Power And Control Cables



AN ISO 9001 : 2015 Company



Mfg. By:
ADDISON CABLE PVT. LTD.
Plot No. P - 87, Road No. B, Opp. V. Trans, Kaland Road,
G.I.D.C. Ladhka, AT - METODA - 360 021, Dist. Rajkot (Guj.) INDIA.
Ph. :- +91-2827-287475/297475 Mo. :- +91 98252 81182
E: info@addisoncables.com W: www.addisoncables.com

Mfgd. By:
ADDISON INDUSTRIES
B/H, Wadkar Enterprises, Atka Street No. 11,
Chhebar Road(South), Rajkot - 360002
Mo. :- +91 99135 15253
Ph. :- +91 281 236037 / 2361596



MINIMATIC®

MOST TRUSTED NAME IN SPM

CNC Turning Center



Sliding Head CNC
(SLD-10 & SLD-20)



CNC Turning Center
(MGT-75)



MINIMATIC MACHINES

Plot No. G-3077, Road L-1, GIDC Ladhka, Alanghry Geta, V.H. Metoda, Dist. Rajkot - 360021.
Mob. 9827271134 | Email : sales@minimaticmachines.com
URL : www.minimaticmachines.com | www.indiamart.com/minimatic-machines

SUPER SLIDE

BALL SCREW, LM GUIDEWAYS & CNC ACCESSORIES



Flexible couplings for Servo Motors

Ballscrew Support Units

MACHINING SYSTEMS

Veer Narmad Township Shop No.-4, Samrat Indl. Area Main Road,
B/H S.T. Workshop, Gondal Road, Rajkot - 360 004. (Guj.)

Contact No. : 097123 59021

E-mail : ballscrew.rajkot@gmail.com

www.superslides.in

સરદાર પતરા

Vardhman Industrial Zone, Plot No-15, S.V. No.-259 B/h-Kothariya Solvet,
Kothariya, Rajkot - 360002. Gujarat (India), Call : +91 87994 54774



AirTract

Total Solution for Air & Pneumatic Equipment



CE AN ISO 9001:2015 COMPANY



MFG. BY:

RAJAN MACHINES (INDIA) PVT. LTD.

AKAR ESTATE, 1ST FLOOR, 3-ATIKA INDUSTRIAL AREA, DHEBAR ROAD (SOUTH), RAJKOT 360 002. (INDIA)

+91 96019 38051, 9081839200, 9081839300

rajanmachinesindia@gmail.com www.rajdhaniaircompressor.com



AMEER

अमीर

An ISO 9001:2015 Company



Century

सेंट्युरी



WIDE RANGE IN COOLANT PUMP



CENTURY AGRO ENGINEERS

2-Umakant Udhyognagar, Mavdi Plot, RAJKOT - 360 004.

Cell No.: 78020 06464 E-mail : ameerrajkot@yahoo.com, Visit us: www.ameerrajkot.com

સરદાર પત્રા

Vardhman Industrial Zone, Plot No-15, S.V. No.-259 B/h-Kothariya Solvet, Kothariya, Rajkot - 360002. Gujarat (India), Call : +91 87994 54774



Manufacturer of EOT Crane & Material Handling Equipments

TOP CRANE®

Maximizing The Human Efficiency



DOUBLE GIRDER EOT CRANE



GOLIATH CRANE



SINGLE GIRDER EOT



JIB CRANE



WIRE ROPE CRAB



WIRE ROPE HOIST



END CARRIAGE



MATERIAL HANDLING SOLUTION

TOP CRANE SYSTEM PVT.LTD.

Maximizing The Human Efficiency

Email : sales@topcrane.in / inquiry@topcrane.in

Website : www.topcrane.in

Mo. : +91 6354 011 480 | +91 97129 77753

Mfg. : All Kinds Of Gunmetal & Phosphorus Bronze Metal Bushes, Split Brass, Gears And Non Ferrous Casting From 10gms To 250kgs As A Single PC Of Precision Components.



ISO 9001 : 2015



SAURASHTRA BRASS INDUSTRIES LLP

"METAL HOUSE", NR. ANDH MAHILA VIKAS GRUH, DHEBAR ROAD, RAJKOT - 360 002 (GUJARAT). INDIA

EMAIL : saurashtrabrass@gmail.com, info@saurashtrabrass.com

WEB : www.saurashtrabrass.com

Mob. : +91 97277 55993, +91 99250 01445

MR. DARSHIT PATEL, MR. PRATIK PATEL

સરદાર પતરા

Vardhman Industrial Zone, Plot No-15, S.V. No.-259 B/h-Kothariya Solvet, Kothariya, Rajkot - 360002. Gujarat (India), Call : +91 87994 54774





**MANUFACTURER AND EXPORTER
OF HYDRAULIC & OTHER TRACTOR PARTS**
Driving Innovation. Powering Agriculture
Your Trusted Source for Quality Tractor Parts!



KALAPI TRACTOR SPARES PVT.LTD.



Fashion redefined, for men of distinction.
Impeccable craftsmanship weaves Italian grace.
A versatile range of pure wool fabrics handpicked
from the heart of Italy where fashion meets
everlasting elegance.



REGIO ITALIA
Handmade in Italy

Available at



RAJKOT
Scan For Location



MORBI
Scan For Location

RAJKOT: Nakshatra-2, 150 Ft. Ring Road, Nr. KKV Circle ☎ 910652077
MORBI: Ram Chowk, Savsar Plot Main Road ☎ 7016086599

ATUL MACHINE TOOLS

Quality is a Matter of Trust



CNC External Grinding Machine
Size : 600 mm & 1000 mm



Hydraulic & Mechanical Cylindrical Grinding Machine
Size : 400 mm to 1500 mm



Hydraulic & Manual Surface Grinding Machine
Size : 600 x 300 mm, 400 x 200 mm

Website : www.atulmachine.com

Almighty Gate, Plot No. P-103, Lodhika G.I.D.C, Kalawad Road, Metoda, Rajkot, Gujarat-360021, India.
Office : +91-2827-297607 | Mob. : +91-8758466424 | Email : sales.atulmachinetools@gmail.com

**Manufacturer &
Importer of :**
All Kind of
Fasteners

माँ



S. N. Enterprise

"Shree Shakti", Godown Road, 14-Bhaktinagar Station Plot,
Nr. Pashu Dawakhana, Rajkot - 360 002.

☎ 90161 03404 ☎ 97266 03404

✉ nemish@sngroups.in 🌐 www.sngroups.in

સરદાર પત્રા

Vardhman Industrial Zone, Plot No-15, S.V. No.-259 B/h-Kothariya Solvet,
Kothariya, Rajkot - 360002. Gujarat (India), Call : +91 87994 54774



VIKRAM
www.vikramvalves.com

 IATF 16949:2016, ISO 14001:2015, ISO 45001:2018
 Certified Company

A Global Supplier of Engine Valves

Serving a Diverse, Global Customer Base for more than 45 years

AVR (Vikram) Valves is one the most reliable and trusted source for **High Quality Engine Valves & Valve Train Components** for a wide array of Industries, including Tier-1 and Tier-2 Automotive Manufacturers. 'Vikram' is now a Globally recognized Brand and Company is matching the footsteps of Globalization by exporting to **USA, UK, Germany, China, South Korea** and almost all over the World.



AVR (Vikram) Valves Pvt. Ltd.

Plot No. 2317-2318, G.I.D.C Lodhika Industrial Estate, Almighty Gate No. 2, Rajkot - 360 021, (Gujarat) India.
 T: +91 2827 287358 | 287359 E: info@vikramvalves.com W: www.vikramvalves.com

સરદાર પતરા

Vardhman Industrial Zone, Plot No-15, S.V. No.-259 B/h-Kothariya Solvet,
 Kothariya, Rajkot - 360002. Gujarat (India), Call : +91 87994 54774

SARDAR
 KOTHIYASOLVET

Kiran INDUSTRIES

K+



ANCHORING YOUR SUCCESS EVERY STEP OF THE WAY



ALLEN CAP BOLTS
HIGH TENSILE HEX BOLTS
HIGH TENSILE HEX NUT

HEX BOLTS & HEX NUT
FLANGE NUT
HEX WELD NUT

COPPER BOLT & NUT
BRASS BOLT & NUT
CUSTOM FASTENERS



RAJ BHALANI
+91 98245-98000

KETAN BHALANI
+91 99045-98000

kiran.fastners@yahoo.com
Sr. No. 211, Plot No. 3, Essan Road,
Al Veraval- Shapar, Tal. Kolda Sangani,
Dist. Rajkot - 360 024, (Gujarat) INDIA.

સરદાર પત્ર

Vardhman Industrial Zone, Plot No-15, S.V. No.-259 B/h-Kothariya Solvet,
Kothariya, Rajkot - 360002. Gujarat (India), Call : +91 87994 54774



MANUFACTURER OF ALL TYPE OF ENGINE VALVE



G-409/410, Opp. Decora Bhavan, G.I.D.C. Metoda, Kalawad Road,
 Rajkot - 360021 (INDIA) | Telefax : +91-2827-287285, 287385
 Email : unicornvalves@yahoo.co.in | Website : www.unicornvalves.com



Mfg. : Mild Steel, Stainless Steel, Manganese Steel,
 Marine Anchor & Alloy Castings
 Capacity : Single Pic - 5 Kg to 4000 Kg.



Poonam Metals

Metoda GIDC, Plot No. G-1330, Opp. Kishan Auto, Kishan Gate, Klawad Road,
 Dist. Rajkot - 360021, Gujarat (INDIA) Mo. : +91 99981 13603, +91 97149 99905
 E-mail : poonammetals1330@gmail.com Web. : www.poonammetals.co.in



સરદાર પતરા

Vardhman Industrial Zone, Plot No-15, S.V. No.-259 B/h-Kothariya Solvet,
 Kothariya, Rajkot - 360002. Gujarat (India), Call : +91 87994 54774



OM METALCAST

SHAPING THE FUTURE

AN ISO 9001:2015 CERTIFIED COMPANY

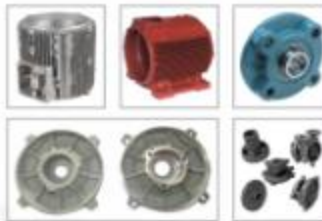

Manufactures of Grey & SG Iron Castings.

Product Range:

- ELECTRIC MOTOR STATOR HOUSING & PARTS
- MOTOR STATOR & SHIELD COVERS
- SUBMERSIBLE PUMP CASTING PARTS
- BEARING COVERS & BEARING HOUSING
- OTHER GRADED GREY & SG IRON CASTING

Office & Work :

Survey No. 280/1, Opp. Prince Villa, Kuvadva-Wankaner Road,
NH-27, Village : Jhiyana, POST: Jhiyana, Dist. Rajkot - 360023. (Gujarat)
info@ommetailcast.com www.ommetailcast.com

Sunilbhai Patel
+91 94262 16320

Milan Patel
+91 92277 60040

Sterling[®]

SUBMERSIBLE PUMPS

CELEBRATING
25 YEARS
OF EXCELLENCE
1997-2022



A Wide Range of Quality Pump Sets



The Most Rugged, Trouble Free & Economical Pump Set.



SIDDHI ENGINEERS

Mfg. : SUBMERSIBLE PUMPSETS

G-2223, Kranti Gate Main Road, Lodhika G.I.D.C., At. METODA, Dist. Rajkot - 360 021 (Gujarat) INDIA.
Phone : +91 2827 287188 • Mo. : +91 79465 00065 • E-mail: info@siddhipumps.in • Web: www.siddhipumps.in

Mfg. of : 0.5 HP to 10 HP SINGLE & THREE
PHASE INDUCTION MOTOR



Mfg. of : ALL SUBMERSIBLE CASTING KIT



BEM Jay Bajarang Electric Manufacture

Laxminnagar Main Road, 6-Mahadev Wadi,
B/h. Haveli, Mavdi Plot, Rajkot - 360 004
E-mail : jaybajrangeleandmanufacture@gmail.com
Ph. : 0281-2371667, Cell : +91 98256 72592



ALL KINDS OF C.I. CASTING MANUFACTURERS



Murlidhar[®] TECHNOCAST

Gondal Road High-way,
B/h. Parin Furniture,
Rani Industrial Area,
Survey No. 17,
Vavdi-Rajkot,
Vallabhbhai Patel
98250 94924



Web : www.murlidhartechnocast.com • Email : murlidhartechnocast@gmail.com

સરદાર પત્રા

Vardhman Industrial Zone, Plot No-15, S.V. No.-259 B/h-Kothariya Solvet,
Kothariya, Rajkot - 360002. Gujarat (India), Call : +91 87994 54774



Rashmi PatelB.E. (Mech), PGDFM
Mo. : +91 98257 09220**Nishant Patel**B.E. (Mech), MBA
Mo. : +91 94295 79366

Mfg. of Bearing Lock Nuts,
Adapter Sleeves,
Lock Washer, Precision Lock,
Nuts and Hook Spanners

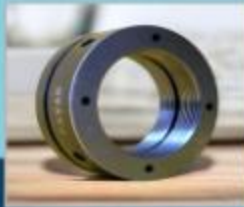

pavan
ENTERPRISE

2, Gokulnagar, Nr. Nirav Commercial Complex,
Gokuldham Main Road, Rajkot - 360 004
Ph.: 0281 - 2312005,
Email : rppatel.pavan@gmail.com

www.stampingsindia.com



QUALITY
The Right
Choice.

We are **Unique** in
Quality Products...



PRECISION
STAMPING INDUSTRIES

Call us now... **098250 76967**

Manu. : All kind of Electrical Stampings & Laminations

Plot No. G-1882-83, M-Road, Kishan Gate, (Gate No. 3)
Nr. Shree Ram Hospital, Lodhika G.I.D.C., Dist Rajkot, At Metoda.

☎ : +91 - 2827 - 287513
☎ : +91 98250 76967

✉ : info@stampingsindia.com
🌐 : www.stampingsindia.com

સરદાર પતરા

Vardhman Industrial Zone, Plot No-15, S.V. No.-259 B/h-Kothariya Solvet,
Kothariya, Rajkot - 360002. Gujarat (India), Call : +91 87994 54774

SARDAR
INDUSTRIES



Engines - Diesel



Spare Part of Engine



Pump & Mud Pump



Oil / Pipe



Manufacturer & Exporter (An ISO 9001:2015 Certified Company)

GUJARAT FORGINGS PVT. LTD.

Opp. N.S.I.C., 80 Feet Road, Aji Industrial Area, Rajkot - 360 003 (India).

Email: info@fieldmarshalengine.com | Customer Care No. +91 99740 56831/32/34

Web: www.speedwel.com | Follow us: @Speedwel | +91 99740 56831

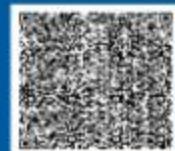

સરદાર પતરા

Vardhman Industrial Zone, Plot No-15, S.V. No.-259 B/h-Kothariya Solvet,
Kothariya, Rajkot - 360002. Gujarat (India), Call : +91 87994 54774



Precision *Aluminium Castings for* Perfect Engineering



"Focussed on delivering estimates that align with your goals, budget and timeline perfectly."

- Precision-Crafted Components**
 Manufactured to meet diverse industrial needs.
- Custom Casting Solutions**
 Expertise in creating parts for automotive, hardware and more.
- Wide Range of Applications**
 Engine parts, brackets, housings and more.
- Trusted by Leading Brands**
 A proven track record across industries for quality.



Contact Us:

+91 99252 31722 | info@tattvanalumicast.com | www.tattvanalumicast.com
 Copper Ind. Area, Shed No. 2 & 3, Opp. Kalpvan, At - Kangshiyall, Rajkot, Gujarat - 360022.



AN ISO 9001 : 2015
Certified Company



Serving
**Pump
Valve**
Earthmoving
Oil & Gas
Industries



RANGE PRECISE
perfection in every micron

**Precision Machined Components
& Sub Assemblies**
Made From **Bar Stock & Forgings**

7, Mani Nagar, Mavdi Plot, Rajkot - Gujrat, India.
 Landline : +91 281-2377797 | Mo : +91 9725552211
 E-mail : sales@rangeprecise.com | Web : www.rangeprecise.com

સરદાર પતરા

Vardhman Industrial Zone, Plot No-15, S.V. No.-259 B/h-Kothariya Solvet,
 Kothariya, Rajkot - 360002. Gujarat (India), Call : +91 87994 54774





The single window to every logistics solution you need

From transportation solutions for different kinds and sizes of cargo, to anywhere-in-India reach and warehousing services and more... V-Tran has it all and is therefore the partner of choice for countless businesses in diverse sectors.



DIFFERENT ARMS,
MANY POSSIBILITIES:



Solutions: Surface transportation, Time-bound express cargo, Warehousing and inventory management, Integrated supply chain



V-Tran (India) Limited Head Office: Unit 06, Corporate Park, V N Purav Marg, Chembur, Mumbai - 400 071.
 ☎ 9870140141 | ✉ info@vtransgroup.com | 🌐 www.vtransgroup.com
 To know more, call us on 9376 888 837 | Email: jignesh@vtransgroup.com

We Believe in Quality

TEZZ®

Air Compressor



Double & Single Cylinder Air Compressor



Manu. & Mrkt. : Air Compressor, Sprayer Pump, Cut off Machine, Electric Air Blower, Electric Motor & Jigsaw Machine.



SHIV SHAKTI ENTERPRISE

Survey No. 32, Plot No. 6, Opp. Poonam Dumper, Street of Perfect Tata Show Room, Rajkot Gondal Highway, Vard, Rajkot-360004 (Gujarat)
 No.: 9428996444, 979277540, 972977960 E-mail: info@tezzaircompressor.in

Filltop®

SUBMERSIBLE PUMPS

एक कदम....
समृद्धि की ओर....



Manu. By : **B.M. ENTERPRISE**

Ankit Industrial Estate, Plot No. 11, Opp. Krishna Park Railway Crossing, Gondal Road, (Kothariya) Rajkot. (Guj.) INDIA
 Customer Care No. : 88 66 74 20 62

સરદાર પતરા

Vardhman Industrial Zone, Plot No-15, S.V. No.-259 B/h-Kothariya Solvet, Kothariya, Rajkot - 360002. Gujarat (India), Call : +91 87994 54774





Mixtron Dosing Unit (Oil and Water Mixing Device)

- Easily mixing oil and water without manpower.
- Stops wastage of oil
- No electricity required
- Very Helpful product for maintaining coolant concentration.

Sump Cleaner

- Extended coolant change period
- Reduce storage and Disposal cost of waste coolant
- Extending Tool life and machine life
- Reducing time in coolant disposal from Machine tank



Cutting Oil

- Improve Tool life and sump life
- Machine cleanliness
- No Human Irritation
- No Bad smell and Rusting issue
- Reduces cutting oil consumption
- Annual Cost Reduction

Oil Skimmer

- Used for removing un-emulsified oil
- Continued cleaning operation
- Easy in maintenance
- Improve coolant sump life



Tapping Machine

- Reduce Tap Breakage issue
- Replace Tapping operations from VMC
- Multiple thread in single machine
- Higher Productivity
- Reduce Tool Changing and Programing Time.

Re-Sharpening Machine

- Easily Regrinding of Drill or Endmill
- Reduce cost of Resharpener (per Endmil or Drill)
- Maximum Grinding on 0.5mm material
- Increases Tool life • Time saving product



Coolant Nozzles

- Universal Coolant Nozzle for CNC machine
- Hits any target above mounting plane
- Adjust easily for accurate coolant placement
- Choose larger orifices for maximum flow
- Nozzle of 10 bar to 100 bar pressure

WE ARE PROVIDING ALL TYPE OF COOLANT MANAGEMENT SERVICES & SOLUTIONS

MASCOT™

CNC Tools & Equipments Pvt. Ltd.

RAJKOT | JAMNAGAR | MORBI | AHMEDABAD

16/28 Vijay Plot, Khodiyar Chowk,
Bhaktinagar, Rajkot-360002 (Gujarat) INDIA.

+91-9023417035 / +91-7698868689

admin.intl@mascootools.in / rushiraj.jhala@mascootools.in

Power by Intellect driven by values



www.mascootools.in

સરદાર પત્ર

Vardhman Industrial Zone, Plot No-15, S.V. No.-259 B/h-Kothariya Solvet,
Kothariya, Rajkot - 360002. Gujarat (India), Call : +91 87994 54774

SARDAR
INDUSTRIAL ZONE



Vacuum Heat Treatment

Call Us On : +91 9408097080



Vacuum Heat Treatment Service Provider For D2, H11, H13, M2, M3/2, All ASP Series, SS 410, SS 420, SS 440c, 17-4 Ph, STAWAX



Plot No.18/1, Survey No. 133, Rameshwar Industrial Area-2, Opp. Sangam technocast, B/H Shantidham Soc., At Veraval (Shapar), Dist. Rajkot, Gujarat - 360024

E-mail : sales@cosmicmetreat.com | Web : www.cosmicmetreat.com



An ISO 9001:2015 Certified Company

"Quality does matter, give others your work, make it working with you, we are all together"

Quality is our Motto....

the complete Plumbing solution



MFG: CPVC, UPVC, SWR, AGRICULTURE PIPES & FITTINGS & FRP CHAMBER COVER & COLUMN PIPE

KAMDHENU POLYPLAST

Add. : Kishan Gate No. 3, Plot No G-2103, Near Fessan Rubber, Metoda GIDC, Rajkot - 360004

Email : kamdhenupolyplast@gmail.com

Web : www.kamdhenupolyplast.com

Mr. Pankajbhai - 93281 32026



MANUFACTURER AND EXPORTER OF HYDRAULIC & OTHER TRACTOR PARTS

Driving Innovation. Powering Agriculture. Your Trusted Source for Quality Tractor Parts!



KALAPI TRACTOR SPARES PVT.LTD.

Postal Add: Survey No. 206, Pal Ravki Road, Opp. Nayra Petrol Pump, RAJKOT, RAJKOT - 360004, (Gujrat) India

Contact: Office : +91 99798 98984, 99254 44609 Email : info@kalapiauto.com Website : www.kalapiauto.com

સરદાર પત્રા

Vardhman Industrial Zone, Plot No-15, S.V. No.-259 B/h-Kothariya Solvet, Kothariya, Rajkot - 360002. Gujarat (India), Call : +91 87994 54774



An ISO 9001-2015 Certified Company

Microtight

FASTNERS LLP

Your Perfect Partner For Fastening Solution

SOCKET HEAD CAP SCREW (M5 TO M16)

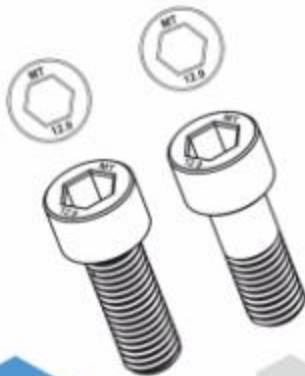

HEX BOLT (M5 TO M16)



OUR CAPABILITIES

- ▶ 3600 MT/Year
- ▶ Multi Station Forming Machine (Cold Forge Headers M5 TO M16).
- ▶ Thread Rolling Machines.
- ▶ Mesh Belt heat Treatment Furnace.
- ▶ Fully Automatic Zinc/ Zinc-Nickel Electroplating Plant.

- ▶ Well-equipped laboratory-
 - Universal Testing Machine with extensometer for 0.2% proof stress Testing Facility.
 - Rockwell Hardness Testing Machine.
 - Micro Vickers Hardness Testing Machine
 - Salt Spray Testing.
 - XRF (X-ray analysis of coating thickness).
 - Metallurgical Microscope with Image Analyzer.
 - Chemical composition analysis (Spectrometer).
 - Vision Measuring Machine.
 - Non-Distractive testing like MP, DP, UT, RT. With ASNT Level II Qualified technical Staffs

Microtight Fastners LLP

Survey No.: 331, Plot No.: 1 & 2,
Nagar Pipaliya Road, DEVLVA,
Taluka : Lodhika, Dist : Rajkot,
Gujarat, INDIA - 360021.

☎ : +91-98240 34150

✉ : amit@microtightfastners.com

🌐 : www.microtightfastners.com

☎ : +91-93753 51003

✉ : info@microtightfastners.com



RAJKOT'S FAVOURITE
WEDDING DESTINATION

PHENIX
RESORT

— 3 BANQUETS ~ 3 PARTY LAWNS ~ POOLSIDE VENUE —

Indoor Capacity > up to **1200** people | **Outdoor Capacity** > up to **5000** people

Ishwariya Road Corner,
Kalawad Road, Rajkot.

Contact **+91 74900 45000**