

FEBRUARY 10, 2025

Volume - 59 Issue - 02

RNI - 11176/67

Price Rs. 50/-

# RAJKOT ENGINEERING INFORMATION BULLETIN

Postal Regn. No. Rajkot/309/2024-2026  
Valid Up to 31-12-2026 Office of Posting RMS-Rajkot.  
Published & Posted on dtd., 10<sup>th</sup> Every Month



RAJKOT  
ENGINEERING  
ASSOCIATION

SINCE 1963  
[www.reaindia.com](http://www.reaindia.com)





“पहेचान  
“नये  
“स्वाद की!

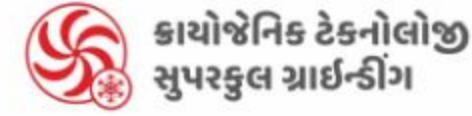

કાયોજેનિક ટેકનોલોજી  
સુપરકુલ ગ્રાઈન્ડીંગ



સ્ટેરીલાઈઝેશન  
ટેકનોલોજી



વેક્યુમ પેકિંગ  
ટેકનોલોજી

મસાલાને સુપરકુલ ટેમ્પરેચરમાં દળાય છે એટલે મસાલાના ગુણધર્મ સુરક્ષિત રહે છે

**દેવપરા આઉટલેટ**

કોઠારિયામેઈન રોડ, દેવપરા શાકમાર્કેટ સામે,  
રાજકોટ, ગુજરાત - 360002  
કોન્ટેક નંબર : +91 99099 20331

**અમીનમાર્ગ આઉટલેટ**

કે.સી.એલ બિલ્ડીંગ ગ્રાઉન્ડ ફ્લોર, સિટી  
સ્કવેર માર્ટ ની સામે, અમીન માર્ગ, ૧૫૦  
ફૂટ રિંગ રોડ નજીક, રાજકોટ - 360001  
કોન્ટેક નંબર : +91 99099 20489

**જુનાગઢ આઉટલેટ**

માનસી કોમ્પ્લેક્સ, જનકપુરી,  
અંજરડા રોડ, જુનાગઢ - 362001  
કોન્ટેક નંબર : +91 99099 13779

Email: sales@farmkingfood.com | Web: www.farmkingfood.com



**Farmking Food Products Pvt Ltd**

UPLIFT YOUR CLASS WITH  
**KICH S. S. 316 GRADE PREMIUM QUALITY**  
ARCHITECTURAL PRODUCTS



Hardware Products



Glass Fittings



Furniture Fittings



Bathroom Fittings



Railing Systems



Digital Solutions

GLIMPSE OF FEW OF OUR PRESTIGIOUS PROJECTS...



CENTRAL VISTA - DELHI



SARDARDHAM BHAVAN  
- AHMEDABAD



ATAL BRIDGE- AHMEDABAD



INTERNATIONAL AIRPORT - PUNE



RAM MANDIR - AYODHYA



All India Institute of Medical Sciences  
(AIIMS) - RAJKOT



INTERNATIONAL AIRPORT - LUCKNOW



BAPS HINDU MANDIR ABU DABI - UAE

**KICH ARCHITECTURAL PRODUCTS PVT. LTD.**

Rajkot-Gondal NH-27, Vavdi, Rajkot-360004 (Guj.) INDIA. Helpline: 1800 212 3836 | www.kichindia.com





Discover  
Comfort & Style



CLUB ROOM



SUPERIOR ROOM



EXECUTIVE ROOM

Get ready to experience comfort like never before. With plush bedding, state-of-the-art amenities, and intuitive design, your RPJ hotel room is your oasis in the heart of the city.

### Our Facilities

- Swimming Pool
- 92 Rooms
- Gym
- Banquets
- 24\*7 Coffee Shop
- Restaurants

+91 281 6167777

Everest Park, Kalawad Road, Rajkot - 360005

www.rpjhotelrajkot.com

reservation@rpjhotels.com

RPJ  
HOTEL  
KALAWAD ROAD, RAJKOT

# RAJKOT ENGINEERING INFORMATION BULLETIN

Volume - 59

Issue - 02

FEBRUARY-2025

Price Rs. 50/-



**RAJKOT ENGINEERING  
ASSOCIATION**

**President**

Shri Narendra V. Panchani



**Vice President**

Shri Jignesh S. Adroja



**Hon. Secretary**

Shri Vinod K. Asodariya



**Jt. Hon. Secretary**

Shri Chandresh Patel



**Hon. Treasurer**

Shri Ashish D. Sardhara



**Editor**

Shri Jay Mavani

## અનુક્રમણિકા

ક્રમ	શિર્ષક	પે.નં.
૧	તંત્રી સ્થાનેથી	૬
૨	ડિરેક્ટરી તથા બુલેટીનના જાહેરાતના દર	૩૧
૩	સંસ્થા સમાચાર	૩૨
૪	કાર્ય સારાંશ	૩૩
૫	ચાલો, ભારતને આધુનિક ટેકનોલોજી રાષ્ટ્ર બનાવીએ : બજેટ ૨૦૨૫ અને સરકારની પ્રોત્સાહક સ્ટાર્ટઅપ સપોર્ટ નીતીઓ : સ્વદેશી વિકાસ તરફ એક મુજબ કદમ	૩૯
૬	રાજકોટ એન્જી. એસોસીએશન ઓડિટોરીયમ હોલ વપરાશ ચાર્જસ	૪૬

મેગેઝિન રાજકોટ એન્જીનીયરીંગ ઇન્ફોર્મેશન બુલેટિન અજય પ્રિન્ટીંગ પ્રેસ, ૨-પટેલનગર, ૮૦ ફુટ રોડ, રાજકોટ-૪ ખાતે છપાવું તેમજ રાજકોટ એન્જીનીયરીંગ એસોસીએશન વતી રાજકોટ એન્જીનીયરીંગ એસોસીએશન, ભક્તિનગર ઇન્ડસ્ટ્રીયલ એસ્ટેટ ખાતેથી શ્રી જય વ્રજલાલ માવાણી દ્વારા મુદ્રિત અને પ્રકાશિત થયું. તંત્રી-શ્રી જય વ્રજલાલ માવાણી.

Magazine "Rajkot Engineering Information Bulletin" Printed and Published by Mr. Jay Vrajlal Mavani on behalf of Rajkot Engineering Association and Printed at Ajay Printing Press, 2-Patel Nagar, Off. 80 Feet Road, Rajkot-4. and published at Rajkot Engineering Association, Bhaktinagar Industrial Estate Rajkot. Editor-Mr. Jay Vrajlal Mavani

Magazine : Rajkot Engineering Information Bulletin  
Volume : 59  
Issue : 02  
Continuous Issue : 698  
Date : 10-02-2025  
Page : 72

સામચિત્ર : રાજકોટ એન્જીનીયરીંગ ઇન્ફોર્મેશન બુલેટિન  
વર્ષ : ૫૯  
અંક : ૦૨  
સળંગ અંક : ૬૯૮  
તારીખ : ૧૦-૦૨-૨૦૨૫  
પાના : ૭૨



## RAJKOT ENGINEERING ASSOCIATION

Bhaktinagar Industrial Estate, G.I.D.C., Street No.-3, Rajkot-360 002.

Ph. : +91-281-2362235 / 36, Mo. +91 99132 14935

E-mail : info@reaindia.com

Website : www.reaindia.com

**Disclaimer** : Statements, Opinions and Views given in the news articles and papers appearing in this Bulletin are the expressions of Contributors, for which the Editor and the Association assume no responsibility

સરદાર પત્રા

Vardhman Industrial Zone, Plot No-15, S.V. No.-259 B/h-Kothariya Solvet,  
Kothariya, Rajkot - 360002. Gujarat (India), Call : +91 87994 54774





## તંત્રી સ્થાનેથી...

તા. ૦૧/૦૨/૨૦૨૫

### “વર્ષ ૨૦૨૫ નું આગમન”

તા. ૦૧/૦૧/૨૫ ના રોજ કેલેન્ડર વર્ષ ૨૦૨૫ નું આગમન થઈ ચુક્યું છે. આ સદીનું એક ક્વાટર પુરૂ થઈ ચુક્યું છે. આજથી ૧૦૦ વર્ષ પૂર્વે પણ દુનિયામાં આમુલ પરિવર્તનો જોવા મળ્યા હતા. એ વખતે વસણથી ચાલતી સ્ટીમ એન્જીન, કોલસાથી ચાલતી રેલ્વે, વ્યાપક ઈલેક્ટ્રીફિકેશન, ટેલીકોમ્યુનિકેશનનો ઉદ્ભવ વગેરે સંશોધનોએ સામાન્ય માણસની હાલતને ધરમૂળથી ફેરવી નાખી હતી. જોગાનુજોગ આજથી ૧૦૦ વર્ષ પૂર્વે આ સદીમાં જેમ કોરોના આવ્યો તેમ સ્પેનીશ ફ્લુનો રોગચાળો કાઠી નિકળ્યો હતો જેમાં સેકડો લોકોના જીવહોમાઈ ગયા હતા. આવુજ કંઈક પુનરાવર્તન લગભગ ૧૦૦ વર્ષ પછી આજે દુનિયાભરમાં જોવા મળી રહ્યું છે. આજે આર્ટીફિશિયલ ઈન્ટેલિજન્સ એટલે કે અઈ અને આયો ટેકનોલોજી સામાન્ય માણસની હાલતને ધરમૂળથી ફેરવી નાખે તેવી પુરી સંભાવના છે. એટલે જ આવનારૂ વર્ષ અને આવનારો સમય આશા અને અરમાનો કરતા ચિંતા અને અનિશ્ચિતતાઓ થી ભરેલો દેખાય છે. વર્ષ ૨૦૧૨ થી વર્ષ ૨૦૨૪ માં જન્મેલા બાળકોને જન્મરેશન આલ્ફા કહેવાઈ છે અને હવે વર્ષ ૨૦૨૫ થી વર્ષ ૨૦૨૯ સુધી જન્મનાર બાળકોને જન્મરેશન બીટા કહેવાશે. આ જન્મરેશન બીટાને કેવી દુનિયા આપણે ઈઈને જશુએ સૌએ વિચારવાનો પ્રશ્ન છે. વર્ષ ૨૦૨૪ દુનિયાભરનું અત્યાર સુધીના ઈતિહાસનું સૌથી ગરમ વર્ષ રહ્યું છે. લગભગ ૧.૫ ટ્રિલિ જેટલો સરેરાશ તાપમાન માં વધારો આ વર્ષે જોવા મળ્યો છે. છેલ્લા ૫૦ વર્ષ દરમ્યાન વાર્ષિક લાર્ડક એટલે કે વન્યજીવોની વસ્તીમાં ૭૩% જંગી ઘટાડો જોવા મળ્યો છે. ૫૦ વર્ષ વટાવી ચુકેલા સૌવ એ વાતના સાક્ષી છે કે આપણા શહેરોમાં પણ એ વખતે જોવા મળતા કાગાળા, ચકલી, ગીધ, સમડી વગેરે જેવા પક્ષીઓ હવે નામ શેષ થઈ ગયા છે. એની સામે વિશ્વની વસ્તી અત્યારે ૮.૦૯ અબજ ને આંખી ગઈ છે અને આ છેલ્લા ૧ વર્ષ દરમ્યાન જ માણસોની વસ્તીમાં ૭.૧૦ કરોડનો વધારો થયો છે. એકલા ભારતમાં ૬૨ વર્ષે ૧૩૦ કરોડ ટનની ખાચ સામગ્રીનો બગાડ થાય છે પછી તે અનાજ અને ઉપજ લણી લીધા પછી ઈઈકે સ્ટોરેજ કરતી વખતે ઈઈકે પછી રાંધેલ અનાજનો બગાડ ઈઈકે.

એવી જ રીતે અનેક કુડ ડિલિવરી પ્લેટફોર્મ દ્વારા પણ રેકોર્ડ બિઝનેસ ગોંધવામાં આવ્યો છે. આમાં જંક ફુડનો સ્ફિરસો મુખ્યત્વે સામેલ છે જેને કારણે આપણી ઈઈંગ હેબીટ પણ બગાડતી જાય છે. આવનારો સમય કેઈક અને કોડ થી સાવચેત રહેવાનો સમય પણ છે. અઈ ના આગમન પછી છેલ્લા એક થી દોઢ વર્ષમાંજ અનેક ભોજા લોકોને ઓનલાઈન ગતકડા કરી છેતરવાની માત્રા અનેક ગણી વધી ગઈ છે. આને કારણે સરકારે પણ રીગટીનમાં ચેતવણીના મેસેજ મુકવા મજબુર થવું પડ્યું છે. એવા અનેક મામલાઓ છે જેમાં માણસ શિશીત થઈને સુધારવાને બદલે બગાડતો જાય છે. અગાઉના વાહનોમાં કિલોમેટર લેમ્પ વાળી પીળી હેડલાઈટ ફીટ કરવામાં આવતી અને એમાં પણ અડધા ભાગ ઉપર પીળો અથવા કાળો પફો લોકો મારતા. આજે અનેક ગણા પાવર વાળી ફીટ લાઈટનું ચલણ છે એમાં પણ શોપીનો વધારાની ફીટ ફીટ કરાવી સામે આવનાર વાહનો અંજાઈ જાય એ રીતે કુલ લાઈટમાં વાહનો હંકારે છે.

જયભાઈ માવાણી  
Cell : 98242 13751  
E-mail : sales@turnmax.in





### :: પ્રમુખશ્રી નો સંદેશ ::

રાજકોટ એન્જીનીયરીંગ એસોસીએશનના ઇતિહાસમાં આ બીજો ભારતના સૌથી મોટો ઇન્ટરનેશનલ ઓટો એક્ષ્પો જે ભારત મોબિલિટી ગ્લોબલ એક્સપો-૨૦૨૫ દ્વારા ૧૭માં Auto Expo-2025 જે યશોભુમિ, દ્વારકા, ન્યુ દિલ્હી ખાતે તા. ૧૭ જાન્યુ. થી ૨૧ જાન્યુ.-૨૦૨૫ યોજવામાં આવેલ જેમાં અદ્વિતીય સફળતા મળેલ એ માટે તમામ પાર્ટીસીપન્ટ્સનો આ તકે અમો એસોસીએશન વતી આ અંકના માધ્યમથી આભાર વ્યક્ત કરું છું.

આ ઓટો એક્ષ્પોમાં રાજકોટ એન્જીનીયરીંગ એસોસીએશનના ૧૧૦૦ ચો.મીટર રો સ્પેસમાં સૌથી મોટા પેવેલીયનના દરેક સ્ટોલની મુલાકાત કેન્દ્રના સ્પોર્ટ્સ, શ્રમ અને રોજગાર માનનીય મંત્રીશ્રી મનસુખભાઈ માંડવીયાએ લીધેલ તેમજ તેમના તરફથી પાર્ટીસીપન્ટ્સ સાથે ભોજન સમારંભ રાખવામાં આવેલ જેને કારણે સૌરાષ્ટ્રના ઉદ્યોગકારોનું પ્રોત્સાહન વધારવાના તેમના આશયને અમો એસોસીએશન વતી બીરદાવવીએ છીએ. આ એક્ષક્લુઝીવ ગ્રુપ પેવેલીયનમાં (૧) બેરીંગ મેન્યુ. પાર્ટીસીપન્ટ અને (૨) અન્ય જનરલ ઓટો મેન્યુ. કેટેગરી નો સમાવેશ કરવામાં આવેલ છે. રાજકોટના કલસ્ટર ની પ્રોડક્ટ્સને નવી ઓળખ આપવાનું અને વિશ્વના ફલક ઉપર રાજકોટના ઓટો પાર્ટ્સ ઉત્પાદનને કરતું હબ બનાવવા માટે રાજકોટ એન્જીનીયરીંગ એસોસીએશન દ્વારા પ્રયત્ન કરવામાં આવ્યો અને જેના હિસાબે રાજકોટને અંદાજે રૂ. ૩૬૦૦ કરોડથી વધારે બીઝનેશ મળી રહેશે એનું અમોને ગૌરવ છે. એસોસીએશન દ્વારા આ એક્સપોમાં ભાગ લેતા આર.ઈ.એ. ના સભ્યોને રાહતના ભાવે સ્ટોલ આપવામાં આવેલ અને જેને લઈને દરેકે દરેક ઉદ્યોગકારોને તેમના બ્રાન્ડીંગમાં સફળતા મળેલ હશે એવું અમો આશા રાખીએ છીએ. ભવિષ્યમાં રાજકોટ એન્જીનીયરીંગ એસોસીએશન દ્વારા યોજવામાં આવતા ઇવેન્ટમાં ભાગ લઈને આપના ઉદ્યોગના વિકાસની તકમાં વધારો કરવા માટે એસોસીએશન સાથે જોડાવવા અમારો અનુરોધ છે.

નરેન્દ્ર પાંચાણી

પ્રમુખ





# AATOMIZE®

NEVER COMPROMISE

**BUSINESS OPPORTUNITY**

## FULLY STONELESS UPTO 10,000 KG FLOUR PLANT



CE ISO 9001:2015

### MASALA PULVERIZER

### 3HP TO 30HP



**1**  
**NUMBER ONE** in Grinding Solution

- Domestic Flourmill
- 2 in 1 Auto Pulverizer
- Masala Machine
- Sugar Grinding Machine
- Rice Mill Machine
- Dal Machine
- All Types of Food Processing Machinery

## AATOMIZE MANUFACTURING PVT. LTD.

Shapar (Veraval), Rajkot-360024, Gujarat (INDIA).

[www.aatomize.com](http://www.aatomize.com) | For Inquiry : 87390 87390



સરદાર પત્ર

Vardhman Industrial Zone, Plot No-15, S.V. No.-259 B/h-Kothariya Solvet, Kothariya, Rajkot - 360002. Gujarat (India), Call : +91 87994 54774







Best Performance Award  
IPMA Award 2019

**NEW PRODUCT**

# ડોનેક્સ સર્ફેસ પ્રોટેક્ટર

## DONEX SURFACE PROTECTOR 1:7

### PINK LIQUID

આ લિક્વિડ ૧ ભાગ + ૪ ભાગ પીવાનું પાણી = કુલ ૫ ભાગ કરવું.  
સબમર્શીયલ મોટરમાં ભરો, ટેસ્ટીંગ કરો, કાઢી નાખો અને રિચુઝ કરો  
આમ કરવાથી, ડીલર ને ત્યાં ૧ વર્ષ પડી રહેલી મોટર્સ પણ ચોક-અપ કે જામ નહિ થાય તેથી રિપ્લેસમેન્ટ ઘટશે.

**Dilution Ratio For Self Priming pump filling purpose-1+7 = 8**

# MAHIR®

**Surface Protector**

SUBMERSIBLE PUMP GRADE - 1:3

For permanent motor filling purpose



- Non Amines Liquid
- Extra Lubrication
- Always free flowing
- Anti-Corrosive Liquid

• NO SIDE EFFECTS ON RUBBER TAPE •

- Best Cooling Properties
- Long Life to inside parts
- Nearly food Grade
- Saves Small Electricity

**Some of Our Valued Customers**

- Texmo-Taro • Texmo - Aquasub • CRI Pumps • Kirloskar • Varuna • Pluga (Franklin - USA)
- Lubi • Samudra • Laxmi - LADA • Panelli - Italy • Unnati • Hayat • Silver • Ajanta • Angel
- Duke • Oswal • Teraflo • Flotech • Rotec • Aden • Penguin etc. So many pump Mfg. companies.



**An Anti-Corrosive Cooling Liquid With Extra Lubrication**

સરદાર પત્ર

Vardhman Industrial Zone, Plot No-15, S.V. No.-259 B/h-Kothariya Solvet,  
Kothariya, Rajkot - 360002. Gujarat (India), Call : +91 87994 54774

SARDAR  
INDUSTRIAL ZONE





+91 99251 04296

info@nandiniind.com

www.nandiniind.com

Atika Ind. Area-2, Opp. Kisan Way Bridge, Atika Dhebar Road(South) Rajkot-2.

**Mfg. ALL TYPE OF C.I. CASTING**

**Molding Process**

- Molasses Sand Casting
- Green Sand Casting
- Nobake Casting
- Shell Core Casting

**Auto Parts Hydraulic Parts**



Fire Safety Hydrant Valve Body

**Grinder & Induction Motor Body Parts**



**Pump Housing Casing Flange**

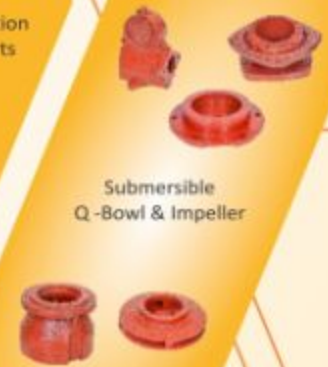

Submersible Q-Bowl & Impeller

**Machine Tools**



Induction Motor



**MEERA CASTING**  
Mfg. : All Kind of C.I. & S.G. Casting

Gear Box



**Industries served**

- Electric motor
- Machine tools
- Gear box
- Pumps and Valves



Manufacturer of Grey Iron and SG iron with facility like Induction furnace from Inductotherm, Continuous sand mixer and Reclamation from Omega UK, Fully equipped Laboratory containing Spectrometer from Bruker Germany, Microscope from Metalsoft with image analyser, UTM, Hardness Tester, sand testing equipments, Shot blasting, Fettling, Painting booth etc...



Survey No. 167, Kothariya Village Main Road, Village Lothada, Rajkot (Gujarat) INDIA.  
E-mail : info@meeracasting.com

સરદાર પત્ર

Vardhman Industrial Zone, Plot No-15, S.V. No.-259 B/h-Kothariya Solvet, Kothariya, Rajkot - 360002. Gujarat (India), Call : +91 87994 54774







**WORLD CLASS TESTING AUTOMATION**  
**FOR ALL KIND OF PUMP & MOTOR**  
**WITH IN-HOUSE NABL LABORATORY**



**WORLD'S**  
**1st**



**INDUSTRIES**  
**SERVED**



Fully Automatic  
(NO Load)  
Routine Test Panel

Smart Power Analyzer  
with  
Pump and Motor  
Evaluation parameter

Electromagnetic  
Flowmeter

More than  
**5000+**  
Customers world-wide

More than  
**200+**  
Standard Products

More than  
**100000+**  
Installation world-wide

**AAROHI EMBEDDED SYSTEMS PVT. LTD.**

THE COMPANY FOUNDED BY ALUMNUS OF IIT, BOMBAY



Plot No. G-(1004-8)A, Kishan Gate No-3 Main road, Nr. Durga Weigh Bridge, GIDC Metoda, Village Lodhika, Kalawad Road, Rajkot, Gujarat (India.) - 360021.

+91-02827 297280

+91 95129 99942



www.aarohies.com

Email: Info@aarohies.com



**NIKOO**  
**TECHNOCAST**  
"Casting Metal to Life"

**"Mfg Of Ductile Iron, Cast Iron & Precision Machined Components."**

**ONE STOP SOLUTION FOR ALL YOUR CASTING REQUIREMENTS**

**We Believe In Cultivating Lifelong Relationships. We Welcome You To Join Nikoo Family.**



+91 74059 87299

www.nikootechnocast.com

Info@nikootechnocast.com

Veraval (Shapar), Rajkot

સરદાર પત્રા

Vardhman Industrial Zone, Plot No-15, S.V. No.-259 B/h-Kothariya Solvet, Kothariya, Rajkot - 360002. Gujarat (India), Call : +91 87994 54774





# आपकी हर जरूरत का साथी

## Speedwel®



परिवार रहे  
स्वस्थ  
जब आटा  
मिले स्वच्छ



  
**SHEETAL LEHER**  
AIR COOLERS

गर्मी में सिर्फ  
शीतल लहेर  
सुपर हिट

**SpeedHot**  
WATER GEYSER

अब स्पीड हॉट गीजर  
के साथ गरम पानी  
पाना एकदम आसान



Manufacturer & Exporter (An ISO 9001:2015 Certified Company)

**GUJARAT FORGINGS PVT. LTD.**

Opp. N.S.I.C., 80 Feet Road, Aji Industrial Area, Rajkot - 360 003 (India).

Email: [info@fieldmarshalengine.com](mailto:info@fieldmarshalengine.com) | Customer Care No. +91 99740 56831/32/34

Web: [www.speedwel.com](http://www.speedwel.com) | Follow us: [f](#) [t](#) [i](#) [c](#) [o](#) [i](#) [n](#) [s](#) @Speedwel | [c](#) [o](#) [c](#) +91 99740 56831

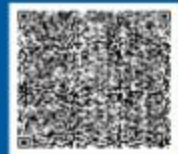

सरधर पत्र

Vardhman Industrial Zone, Plot No-15, S.V. No.-259 B/h-Kothariya Solvet,  
Kothariya, Rajkot - 360002. Gujarat (India), Call : +91 87994 54774

**SARDAR**  
SARDAR ENGINEERING



Since : 1982



WELDING TECHNOLOGY



AN ISO 9001:2015  
CERTIFIED COMPANY



**Manufacturers of :**  
**All Type of ARC Air & Oil Cooled Welding Machine, Spot Welding, Pneumatic Type Spot Welding, Hand Spot Welding, ARC Inverter Welding, Tig Welding, Mig Welding, Plasma Cutting, Welding Equipments & Step-up Transformers.**



**ARC**

**SPOT**

**PNEUMATIC**



**INVERTER TIG**

**INVERTER MIG**

**INVERTER CUT**

**Always ahead for it's quality, workability & availability**



**RAJLAXMI  
ELECTRICALS PVT. LTD.**

Regd. Office :  
 Plot No. C-D-38, 4, Atika Ind. Area, Weldor Street,  
 Kishan Chowk, Dhebar Road (South), RAJKOT-360 002. (INDIA)

Phone : +91-281-2361937, 2365621, Mob.: 9978975261

e-mail : rajlaxmiwelding@yahoo.com  
 web : www.welding-transformer.com

We are an ISO 9001:2015 Company, established in 1983 based in Rajkot and continuously working with Best Quality, Best Price & Timely Deliveries as its mission ever since. SQC is engaged in manufacturing of different types of Investment Castings by lost wax process for Submersible Pumps, Process Pumps, Centrifugal Pumps, Industrial Valves, Cam-Lock Couplings, Aerospace, Agriculture Equipments, Construction Equipments, NRV Couplings, Plumbing Valves, Railways, Marine, General Engineering, Automobiles, Firefighting Range, Food Industries, Dairy & Textile Machineries, Ortho Implants etc. in Ferrous metals such as Stainless steel, Alloy steel, Carbon steel, Duplex steel, Super alloys amongst others and Brass in Non- Ferrous segment.



## "we Cast What You Think"











Unit 1 : Behind Rajkamal Petrol Pump, Off Gondal Road,  
RAJKOT - 360 004. GUJARAT (INDIA)

Unit 2 : Survey No. 216, Muktidham Road, Before Railway Crossing,  
Veraval (Shapar) - 360 024. GUJARAT (INDIA)



**SUPER QUALI CAST (INDIA) PYT. LTD.**  
 MFRS. : PRECISION INVESTMENT CASTINGS

☎ 91-281-2388848    ✉ info@superqualicast.com    🌐 www.superqualicast.com

**સરદાર પતરા**

Vardhman Industrial Zone, Plot No-15, S.V. No.-259 B/h-Kothariya Solvet,  
 Kothariya, Rajkot - 360002. Gujarat (India), Call : +91 87994 54774





Amit Hansalia  
+91-99740 38980

An ISO 9001 : 2015 Certified Company

Vijal Gandhi  
+91-99740 12322

# Shakti

Shakti Heat Treaters & Engineers

Specialist in All type of Heat Treatment process

A Well known and one of the Biggest Heat Treatment Company in the Region  
Having More than 100 Customers.

- Forgings
- Investment Castings
- Sand Castings
- S.G. Iron
- C.I. Castings

### Machinery

- Gas Fired Pit Type Furnace Temp. 1200 °C
- Gas Fired Pit Type Air Circulated Tempering Furnace
- Electric Pit Type Atmosphere Controlled Carburising Furnace
- Electric Pit Type Air Circulated Tempering Furnace
- Electric Pit Type Air Circulated Solution Treatment Furnace working temp. 1200 °C
- Oil Quenching Tank - 30000 ltr & 12000 ltr
- Water Quenching Tank - 35000 ltr, 15000 ltr & 10000 ltr
- Online Temperature Monitoring Systems

We do

- S.R. Normalizing, Annealing,
- Hardening, Tempering
- Precipitation Hardening, N.Q.T.
- Solution Annealing Upto 1200 °C
- Oil & Water Quenching
- Carburising, Case Hardening

### Testing Facility

- Brinell Hardness Tester Computerized
- Rockwell Hardness Tester
- Micro Vickers Hardness Tester
- Portable Hardness Tester
- Microscope

Job Capacity Up to - 1.5 tons Single Pcs  
(2300 MM length x 1300 MM Dia)



### Office & Works - Unit - 1

Survey No. 163/1-P, Plot No. 3, SIDC Road,  
Veraval (Shapar) Tal. Kotasangani, Dist. Rajkot  
Phone No.: +91 - 2827- 252067  
Email : shaktiheat@gmail.com

### Works - Unit - 2

Survey No. 225, Plot No. 39/40/41, Shreenathji  
Industrial Zone, Near Gundasara Railway Crossing,  
At. Gundasara Village, Tal. Gondal, Dis. Rajkot

Manufactured with  
Quality "Telegraphic Channels"

## EISEN

Eisen Hardware Solutions Pvt. Ltd.  
117, W/O. J. K. Shah & Co. Industrial Park  
Rajkot (Gujarat) INDIA  
www.eisenhardware.com

OEM  
AVAILABLE



Premium  
Quality

- Extra Smooth 3 Ball Runner
- Load Capacity 45 kg.
- Long life Locking System
- 120hours slot spary Tested
- Extra Full Extension
- German Technology Plating
- Available Length 10 to 24 inch
- Finish :- Zinc, Black



સરદાર પત્રા

Vardhman Industrial Zone, Plot No-15, S.V. No.-259 B/h-Kothariya Solvet,  
Kothariya, Rajkot - 360002. Gujarat (India), Call : +91 87994 54774

SARDAR  
INDUSTRIAL ZONE





**WE PROVIDE SOLUTIONS**

Server, Computer, Laptop Sales & Service

Hardware & Networking Services

Annual Maintenance Contract (AMC)

IP / CCTV Camera Solution / Installation

Network Security Solution

All Type of Corporate Office Communications Solutions (Video Conference System, EPBX, etc.)



Sagar Parsana  
+91 98981 02907  
+91 90333 28628  
pcpointcare@gmail.com

"Samrudhi bhavan",  
Shop No.74, 3<sup>rd</sup> floor Gondal rd,  
Opp. bombay petrol pump,  
Rajkot - 360002



**AN ISO 9001 : 2008 Certified Company**



Web : www.honestyengworks.com  
E-mail : info@honestyengworks.com  
Mobile : +91 8000 382199 (KRUNAL)



**HONESTY ENGINEERING WORKS**

Manu. of High Tensile Bolt, Studs, Nut, Center Bolt & I Bolt

Office: 2, Bhaktinagar Station Road, Rajkot-2. Ph.: 0281-2461040  
Factory: 9, Aji Vasahat, 80 Feet Road, Rajkot-3. Ph.: 0281-2389009 Cell : 098240 76100



**MANUFACTURERS OF SCREW TYPE AND RECIPROCATING TYPE SINGLE STAGE & DOUBLE STAGE AIR COMPRESSORS**

ALSO DEALS IN AIR DRYER, SERVICE PUMP, GREASE PUMP, OIL FREE AIR COMPRESSOR TRACTOR MOUNTED AIR COMPRESSOR AND OTHER PNEUMATIC ACCESSORIES



Screw Air Compressor, Reciprocating Single Stage Single Cylinder, Reciprocating Single Stage Double Cylinder, Reciprocating Double Stage Double Cylinder



Reciprocating Double Stage Three Cylinder, High Pressure Air Compressor, Service Pump, Grease Pump



Air Drier, Tractor Mounted Air Compressor 200M, Air Receiver

Office : 99130 00962 Accounts : 94087 09277  
Service : 99130 00961 Sales : 99042 99969 96735 35982  
Web : www.toyo.in Email : info@toyo.in

For **UNMATCHED Quality PERFORMANCE**



**टोपलैंड Topland توب لاند**  
topland-india.com

India's Top Export Brand in WATER & POWER SOLUTIONS



an ISO 9001 2015 certified company



हम हैं भारत के नं.1 एवं एकमात्र निर्यात की जाकी हर क्वॉलिटी के अनुसार उत्पन्न करते हैं।

**Topland Assorted Product Range :**

- Diesel / Petrol Engine / Pumpset : 1.5 HP to 200 HP
- Pumpset / Monobloc / Openwell : 0.5" x 0.5" to 14" x 14"
- V3 to V30 - Submersible Pumps : 0.5 HP to 520 HP
- A.C. Generator/ Silent Genset : 1 KVA to 200 KVA
- Domestic Flour Mills : 1 to 3 HP
- uPVC & PVC & SWR Pipes & Fittings : upto 2" Size
- Suction Hose Pipes : upto 8" Size
- Garden Pipes : upto 1.5" Size
- HDPE Pipes : upto 4" Size
- Agri Pipes : upto 10" Size
- Column Pipes : upto 4" Size
- Rotavator : 4" to 8" (Feet)



Manufacturer & Exporter :

**Topland Engines Pvt. Ltd.**

2-Ghansari Parikh Udyog Nagar, Main Plot, Rajkot - 360 004 (GJ)  
Phone : +91 291 238411/2/3, 238022/3/4 Mobile : +91 90741 25002  
E-mail : topland\_india@toplandeng.in export@toplandeng.com

Toll Free : 1800 233 88888

AN ISO 9001:2008 Company

सरधर પત્ર

Vardhman Industrial Zone, Plot No-15, S.V. No.-259 B/h-Kothariya Solvet, Kothariya, Rajkot - 360002. Gujarat (India), Call : +91 87994 54774







15 kg to 1000kg  
Green Sand and No back Process

## CI & SG Iron Casting - as per Your Pattern.

### Accord Inducto Cast

Quick Contact 'ACCORD', Plot NO.5,  
Survey No.45, Nr. Bharat Nagar,  
Vavdi, Rajkot - 360004,  
Gujarat - INDIA.



Valve and Pump Castings



Gear & Transmission Parts

### Mr. Ketan Gajera

+91 99988 44445  
sales@accordcasting.com  
www.accordcasting.com



Machinery Castings

Excellent Attitude &  
Performance Lead to Quality



AN ISO 9001 : 2015 COMPANY



THE 100% PERFECT CHOICE FOR  
YOUR WORKSHOP



Mechanic's Bench Vices  
(With Fixed or Swivel Base  
Oxford Blue Color)



Mechanic's Bench Vices  
(With Fixed or Swivel Base)



Heavy Duty Drill Vices  
(Six Slot Clamping)



Heavy Duty Drill Vices



Bench Grinder Stand



Milling Machine Vices



Heavy Duty Precision  
Pipe Vices



Woodworking Vices  
Plain Screw



G - Clamp



Lock Down Jaw Machine Vices



Cress Slide



Tool Post Vices



Angle Plates  
(7.1 Machine  
7.2 Precision Ground)



AN ISO 9001 : 2015 COMPANY  
Mfg. Heavy Duty Precision Vices

### ACCORD ENGINEERING CORPORATION

"ACCORD", 4-Atika Industrial Area, Dhebar Road (S), RAJKOT - 360 002 (Guj) INDIA.  
Mo : Chaturbhai Gajera : 97264 81272, Ketan Gajera : 99988 44445  
Email : sales@accordbenchvices.com | Web Site : www.accordbenchvices.com



સરદાર પત્રા

Vardhman Industrial Zone, Plot No-15, S.V. No.-259 B/h-Kothariya Solvet,  
Kothariya, Rajkot - 360002. Gujarat (India), Call : +91 87994 54774







We are an IATA accredited travel Company. We make your travel economical, safe, fun, informative, comfortable & memorable.

We feel obliged to introduce our ambitious venture "PATEL HOLIDAYS" as an entity which takes care of any tour & travel requirements of its estimated time at global level. Since inception, in 2006, we have been an IATA accredited travel Company.

PATEL HOLIDAYS has been venturing into a new geographic arena and making utmost effort to make the best deal available to its clients.

- Holidays Tour Package (Inbound & Outbound), Family Group Package, Corporate Groups, Dealers Group, MICE & Student Groups, Teacher Groups & Spiritual Tours.
- Air ticket (Domestic & International).
- Gulf country VISA stamping including medical.
- Passport processing (New & Renewal) & Student Passports & Groups.
- Travel insurance.
- Worldwide Hotel Bookings.
- Tourist Visa, Business Visa, Conference Visa.

PATEL HOLIDAYS is a one-stop enterprise that offers the complete range of travel related services. Superior knowledge, efficient planning and the ability to anticipate & resolve potential problems along the way are the reasons behind our success.

Till date, we have handled over 50,000 guests who have taken advantage of our valuable services.

We are awarded for the excellent performance of selling Yas Island for the year 2023 by Abu Dhabi Tourism.



**MR. SHAILESH PADARIYA**

Founder Director  
Patel Holidays

### Our Expertise

U.K & USA Passport Renewal,  
Schengen Visa (Europe), Australia,  
Canada, China Tourist & Business Visa)

### Specialised in Group Tour

Dubai, Japan, Singapore, Malaysia,  
Thailand, Bali, Vietnam, Europe, South  
Africa, Himachal, Kashmir, Leh-ladakh,  
Goa, Andaman-Nicobar, Kerala,  
Karnataka, Uttarakhand, Sikkim.



### OUR AWARDS



### OUR PRESENCE

- **RAJKOT HEAD OFFICE** -  
3rd Floor - Kevalam Complex,  
B/H Umiya Mobile,  
Astron Chowk, Rajkot - 360001  
☎ +91 98791 24774

- **RAJKOT BRANCH OFFICE** -  
115, Shivam Complex,  
Sarweshwar Chowk, Jagnath Plot,  
Dr. Yagnik Road Rajkot - 360001  
☎ +91 63527 64669 / +91 72850 26567

- **AHMEDABAD OFFICE** -  
612, Aaron Spectra,  
Rajpath Rangoli Road,  
Bodakdev, Ahmedabad - 380054  
☎ +91 96621 61109 / +91 94281 54133

- **SURAT OFFICE** -  
U-4, Jolly Square, Nr. Ram Chowk,  
Ghod Dod Road, Surat - 395001  
☎ +91 75979 5238 / +91 97261 11880

138, Avadh Viceroy, Sarthana  
Jakat Naka, Nana Varachha,  
Surat - 395006

- **JAMANAGAR OFFICE** -  
152, Neo Square,  
Ambar Cinema, Jamnagar-361001  
☎ +91 76983 08248

- **JETPUR OFFICE** -  
IB Complex, Junagadh Rd,  
Jetpur - 360370  
☎ +91 87348 86500

**PATEL HOLIDAYS**  
TRAVEL SOLUTIONS PVT. LTD.

☎ +91 98791 24774  
✉ shailesh.patelholidays@gmail.com

સરદાર પતરા

Vardhman Industrial Zone, Plot No-15, S.V. No.-259 B/h-Kothariya Solvet,  
Kothariya, Rajkot - 360002. Gujarat (India), Call : +91 87994 54774

**SARDAR**  
JOURNAL





**VISHAL** SUBMERSIBLE PUMP SET

MFG. :  
V-3, V-4 SLIM, V-4, V-5,  
V-6 BORWELL &  
OPENWELL SUBMERSIBLE PUMPSET

**VISHAL ENGINEERS**  
Golden Industrial Area, Plot No. 6, B/h. Rolex Rings Pvt. Ltd.,  
Railway Crossing, Opp. Krishna Park Hotel, Gondal Road,  
Village : Kothariya - 360 022. Dist. Rajkot.  
E-mail : Vishalengineers2012@gmail.co  
Web : www.vishalpump.com  
Cell : 094271 55599 / 94274 60888 / 099791 11055



**ACCURATE** since 1982  
Precision Lathe Machines & SPMs

An ISO 9001:2015 Company  
known for its accuracy

High Speed All Geared Lathe Machines  
Heavy Duty All Geared Lathe Machines  
Heavy Duty Lathe Machines  
Extra Heavy Duty Lathe Machines

Exported to Countries: USA, UK, ITALY, SOUTH AFRICA, SWITZERLAND, BANGLADESH, INDIA, SRI LANKA, GERMANY, POLAND, AUSTRIA, BELARUS, ROMANIA, GREECE, ITALY, CHINA

**ACCURATE MACHINE TOOLS**  
www.accuratelathe.com

13, Atika Industrial Area,  
Drahter Road South,  
Rajkot - 360 002, INDIA

Phone: +91 281 2301099  
Mobile: +91 98242 22668  
E-mail: info@accuratelathe.com

© ACCURATE, ACCURATE MACHINE TOOLS and 'EAGLETURN' are REGISTERED TRADEMARKS. Imitation, Reproduction, Duplication, Translation, etc. of our Regd. Trademarks are strictly prohibited and legally punishable as per Trademark Act, 1999



**VEDANT LOGISTICS**

Combining the latest logistics technology with high-quality services, and the ability to offer customised solution

**Our Services :**

- Export & Import air & sea freight
- Custome Brokerage
- Ad Code Registration
- Self Sealing Permission
- Rex Registration
- Coastal Services
- Transportation

**Our Network :**

- Kandala
- Mundra
- Nhava Sheva (Mumbai)
- Ahmedabad ICD
- AIR - Ahmedabad
- AIR - Mumbai
- Hazira
- ICD Vernama (Baroda)
- Chennai & Major Ports

**CONTACT US :**

**Registered Office**  
Vedant, Geet Gurjari Society,  
Street no. 2, Airport Road, Rajkot -  
360007, Gujarat, India  
**Email ID**  
info@vedantlogistics.co.in  
**Cell**  
+91 90990 12199 / 94080 04365

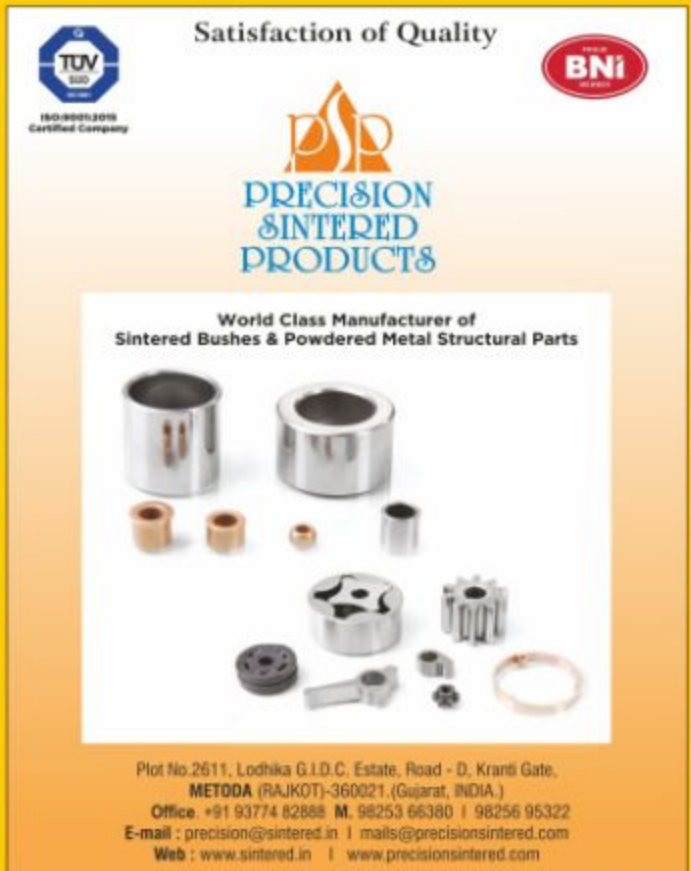

**Satisfaction of Quality**

**PRECISION SINTERED PRODUCTS**

World Class Manufacturer of  
Sintered Bushes & Powdered Metal Structural Parts

Plot No.2611, Lodhika G.I.D.C. Estate, Road - D, Kranti Gate,  
**METODA (RAJKOT)-360021. (Gujarat, INDIA.)**  
Office: +91 93774 82888 | M. 98253 66380 | 98256 95322  
E-mail: precision@sintered.in | mails@precisionsintered.com  
Web: www.sintered.in | www.precisionsintered.com







# HRIDAY ENTERPRISE

All Types Of Industrial Rack Manufacturer



Heavy Duty and Light Duty Industrial Rack



**Address :** b/s. Yes Bank, Panorama Complex, Chhaniara Building, Opp. Shivalki-7, Opp SBI Bis, Gondal Rd, Rajkot, Gujarat 360002  
**Mob. :** +91-98989 99588, +91-98980 99588  
**Email :** hridayenterprise@gmail.com  
**Web :** www.hriday.chaniaragroup.com



**1<sup>st</sup>** Lab of Saurashtra-Kutchh to have **NABL** Accreditation.

### WHY CALIBRATION WITH "KRISHNA INSTRUMENTS LLP." ??

- Most standard & advanced master instruments.
- Experienced and trained man power.
- Systematic approach towards handling of instruments.
- Quick delivery - less hold time.
- Established calibration laboratory since **2001**

**WE CALIBRATE**

PRESSURE, VACCUME GAUGE & B.P. INST. (-1 to 300 bar)	TEMPERATURE METER & THERMOCOUPLE	MULTIMETER	CLAMP METER (1000 Amp)
PROCESS INSTRUMENTS	PT CALIBRATION	TAN DELTA	
TACHOMETER (9000 RPM)	POWER ANALYZER	FLOW METER	CURRENT TRANSFORMER (1000 Amp)

- Weight, Balance
- Thermo/Hygro
- Mass Calibration



**KRISHNA INSTRUMENTS LLP.**  
 "OM" 5/B, Gopal Nagar, Opp. Gopal Temple, Gopal Nagar Main Road, RAJKOT-360002INDIA.  
 ☎ : +91 8866 11 7788  
 ✉ : Calibration@krishnainstruments.com  
 🌐 : www.krishnainstruments.com

સરદાર પત્રા

Vardhman Industrial Zone, Plot No-15, S.V. No.-259 B/h-Kothariya Solvet, Kothariya, Rajkot - 360002. Gujarat (India), Call : +91 87994 54774





*"Don't be a fool - use the proper tools"*

SAFETY PRODUCTS | PPE PRODUCTS | FIRE SAFETY  
ROAD SAFETY | POWER TOOLS | TOOLS ABRASIVES  
WELDING SOLUTIONS | PACKAGING | PAINTS ADHESIVES  
HAND TOOLS | ELECTRIC MOTORS



Email : [omtrading139@gmail.com](mailto:omtrading139@gmail.com) | Mo. 72039 00139, 97235 92165  
G/911-A, Kishan Gate, Lodhika G.I.D.C., Kalawad Road, Metoda, Dist. Rajkot (Guj)-360021.



## MATRIX WEIGHBRIDGE & INTELLIGENT TERMINAL

PIT LESS WEIGHBRIDGE



PIT MOUNTED WEIGHBRIDGE



MODULAR WEIGHBRIDGE



**1 INTEGRATED INTELLIGENT TERMINAL**

### Product Features

- ✦ Rugged And Robust Design
- ✦ High Record Storage
- ✦ High Strength Structure
- ✦ Designed For Harsh Environment
- ✦ Easy Transportation And Installation
- ✦ Designed And Manufactured Very Precisely
- ✦ Minimum Installation Time
- ✦ Easy Maintenance And Cleaning

**Matrix Weighing Systems Pvt. Ltd.**

Plot no. 12, Survey no. 32, Rajkot Gondal Highway,  
Behind TATA Perfect, Beside Poonam Dumper,  
Vavdi, Rajkot - 360 004, Gujarat, INDIA.

Cell: +91 98250 75183

+91 90990 92850

Email: [info@matrixwb.com](mailto:info@matrixwb.com)

Web: [www.matrixweighbridge.com](http://www.matrixweighbridge.com)



સરદાર પત્ર

Vardhman Industrial Zone, Plot No-15, S.V. No.-259 B/h-Kothariya Solvet,  
Kothariya, Rajkot - 360002. Gujarat (India), Call : +91 87994 54774







A COMPLETE PRINTING & PACKAGING SOLUTION



# CATALOGUE  
# PAPER BAGS

# POUCHES  
# PRINTED LABELS

# PREMIUM BOXES  
# AND MANY MORE...

# DUPLEX BOXES  
# CORRUGATED BOX

**PRINTWELL OFFSET**  
37B/A, AJI G.I.D.C MAIN ROAD, NR. BAVISHI WEIGHT BRIDGE,  
OPP. SAHKARI MANDLI,RAJKOT - 360 003, (GUJARAT) INDIA.

**CONTACT US : + 91 93777 15636**

FOLLOW US ON :



WWW.PRINTWELLRAJKOT.COM  
WWW.MULTITONPOLYPACK.COM

**MULTITON POLYPACK PVT. LTD.**  
PLOT NO:-219, AJI G.I.D.C, PHASE - II, MAIN ROAD,  
220A, N-ROAD, RAJKOT - 360003, (GUJARAT) INDIA.  
**MPPL (UNIT - 2)**  
SURVEY NO. 284/1, 284/2, NEAR RK UNIVERSITY,  
KASTURBADHAM (TRAMBA),  
RAJKOT-BHAVNAGAR HIGHWAY - 360020

**CONTACT US : +91 99139 99949, +91 76210 02030**

Vipul Patel +91-98791 74713 Office +91-98791 72466

**SHIVAM MINERALS & ALLOYS**  
Supplier of all types of Ferrous & Non Ferrous Metals

**SHIVAM Group of Company**  
"Providing Quality to Inspire your Trust"

**Athorised Dealer**  
CUMI murugappa Carborundum Universal Limited

Nickel  
Ferro Moly  
Ele. Iron  
Fe Manganese Lc.  
Fe Chrome Lc.

- Ferro Silicon (Metal,Zirc.,Cals.)
- Manganese (Metal,Lc,Mc,Hc)
- Chromium (Metal,LC,MC,HC)
- Nickel (Falcon,Inco,Chips)
- Molly Metal & Ferro Molly
- Zinc Ingot (Hindustan)
- Iron Lumps (Hoganas)
- S.S. Melting Scrap
- Tin (Metal & Ingots)
- Ferro Vanadium
- Aluminum shots
- Selenium Metal
- Tungsten Metal
- Cobalt Metals
- Ferro Titanium
- Ferro Niobium

**Sixty Eight METALS**

+91-74054 47074  
+91-63539 44531  
www.sixtyeightmetals.com

**PRECISION TECHNOLOGY PVT. LTD.**

+91-90991 11796  
Ph. - 02827-296001  
www.precisiontechnocast.com

**ARKH DEVELOPERS**

+91-98791 74713  
www.arkhdevelopers.com

Plot No:-10, Opp. Sardar Starch,  
Nr. Gujarat Alloy Cast, Pan Business Park Gate,  
Shapur (Veraval)-360 024 (Guj.) INDIA - Ph. :- 02827 - 299263  
Email :- shivammineralsandalloys@gmail.com  
Web :- www.shivammineralsandalloys.com

સરદાર પતરા

Vardhman Industrial Zone, Plot No-15, S.V. No.-259 B/h-Kothariya Solvet,  
Kothariya, Rajkot - 360002. Gujarat (India), Call : +91 87994 54774





# GUGAN

SURFACE FINISHING AUTOMATION  
AND ELECTROPLATING PEOPLE



**SINCE 2014**  
7 YEARS OF EXCELLENCE  
Innovation, Quality, Commitment

## About Our Company

Gugan Engineering Company founded in year 2014, set out itself to be a leading solution providers in surface finishing industry. GEC, was formed by first generation entrepreneurs & technocrats. The company has a strong research base with technology, research and development. Gugan Engineering established the state of art manufacturing facility to offer customers and clients the best of technology in industry.

Process lines are specifically designed for all types of surface finishing applications. multiple manufacturing facilities permit flexible customization for every customers need and unique application and delivery requirements.

## Our Expertise

- ❖ Alkaline Zinc Plating Plant
- ❖ Zinc Nickel Plating Plant
- ❖ Acid zinc Plating Plant
- ❖ Copper Plating Plant
- ❖ Anodizing Plant
- ❖ Phosphating Plant
- ❖ ABS Plating Plant
- ❖ PCB Plating Plant
- ❖ Silver Plating Plant

## Process Automation of Plating Industry

- ❖ Process Efficiency
- ❖ Cycle Optimization
- ❖ Productivity Improvement
- ❖ Mixed Cycle Program
- ❖ ERP / SAP Integration
- ❖ Energy Management in Plating Plants



Contact us for your automatic plating line requirements

## GUGAN ENGINEERING COMPANY

No: 60/2A & 61/2A, Chettiyar Agaram Main Road, Chettiyar Agaram, Chennai - 600077  
9894164686, 9043896720 | arun@guganengg.com | www.guganengg.com

સરદાર પત્ર

Vardhman Industrial Zone, Plot No-15, S.V. No.-259 B/h-Kothariya Solvet,  
Kothariya, Rajkot - 360002. Gujarat (India), Call : +91 87994 54774

**SARDAR**  
Engineering & Technology



**SINCE : 2000**



**TOP** SAFETY  
QUALITY  
CUSTOMER  
SATISFACTION



LIFT MFG., MODERNIZATION & MAINTENANCE



**2,500+**  
Elevators  
Manufactured



**400+**  
Client Base



**20+**  
Cities in India



#### Our Products :

- Passenger Lift
- Capsule Lift
- Hospital Lift
- Goods Lift
- Dumbwaiter
- Car Lift
- Hydraulic Lift

### TOP INDIA ELEVATOR PVT. LTD.

#### Head Office :

205 - B, Crystal Commercial Complex.,  
Nr. K.K.V. Hall, 150 Feet. Ring Road,  
Rajkot - 360005. Gujarat. INDIA.

Phone : 0281-2587835

Mobile : + 91 - 9924130748

E-mail : [info@topindiaelevator.com](mailto:info@topindiaelevator.com)

Website : [www.topindiaelevator.com](http://www.topindiaelevator.com)

#### Factory :

G-1127-1128, 1C Road, Lodhika G.I.D.C.  
Kishan Gate, Nr. Rajendra Cold Storage,  
Kalawad Road, Metoda. Rajkot - 360021  
(Gujarat-India) Mobile : +91 99241 96662

**Branch Office : Bhavnagar, Surat, Junagadh, Vadodara.**

સરદાર પત્રા

Vardhman Industrial Zone, Plot No-15, S.V. No.-259 B/h-Kothariya Solvet,  
Kothariya, Rajkot - 360002. Gujarat (India), Call : +91 87994 54774

SARDAR  
ELEVATOR



AN ISO 9001:2015 COMPANY  
**ZMR**  
SOLAR ENERGY

जल है तो कल है,  
ZMR पंप है तो सालो साल है

8.455 hp  
Up to 350hp  
2000 feet  
Capacity



Domestic, Industrial, Agriculture, Pumps & Motors



Manufactured By  
**RANJAN INDUSTRIES**  
Gandhi Road, 8th S.T. Road, Sector Industrial Area, Opp. Usha International, Rajkot-360004  
E-mail: ranjan244@gmail.com / E-mail: ranjan@ranjanindustries.com  
Web: www.ranjanindustries.com  
Toll-Free No.: 1800 1234 181



AN ISO 9001:2015 COMPANY  
**ZMR**  
SOLAR ENERGY

"ऊर्जा के स्रोत को बिना नुकसान पहुंचाये ऊर्जा प्राप्त करना"



Solar Residential & Industrial Rooftop, Ground Mount Power Plant, Solar Water Pumping System



Manufactured By  
**RANJAN INDUSTRIES**  
Gandhi Road, 8th S.T. Road, Sector Industrial Area, Opp. Usha International, Rajkot-360004  
E-mail: ranjan244@gmail.com / E-mail: ranjan@ranjanindustries.com  
Web: www.ranjanindustries.com  
Toll-Free No.: 1800 1234 181



Manoj Bhalala  
98242 31034



**PRAMUKH INSTRUMENTATION**  
"MOHAN KUNJ", 2-Bhakti Nagar Station Road, Rajkot-360 002.  
Cell : 94290 49123, 75679 49798 | Email : pramukh.ins@gmail.com



**LUXURIA**  
Innovative Paints  
પંજી જો લાભથી રે...!



**INDUSTRIAL CHOICE FOR**  
Interior | Appliances  
Furniture | Machinery

MANUFACTURED BY  
**LUXURIA PAINTS**  
Office : Sanskar Industrial society Main Road,  
Nr, National Highway 8-B, Rajkot - 360003.  
Factory : Plot No. 40 to 44 & 55 to 57 Survey No.: 251 to 255  
Gokul Industrial Park - 2, Taluka: Kotda sangani,  
Village Piplana, Rajkot - 360024 (Gujarat) India.  
Customer Care No.: 8181981814, 9099007256  
E-mail : info@luxuriapaints.com





# One Stop Solution

FOR ALL KINDS OF ENGINEERING CUTTING TOOLS, TAPS, CBN/PCD INSERTS AND INDUSTRIAL LUBRICANTS



HSS-E & HSS Taps

OUR PRODUCT PORTFOLIO INCLUDES

**MEBA** sawing solutions.  
Bimetal Bandsaw Blades  
Bandsaw Blades & Circular Saw Cutters

**MEBA** sawing solutions.  
Bandsaw Machines & Circular Saw Machines

**MAGNACOO**  
Quality | Performance | Value  
Industrial Oil  
Industrial Lubricants  
Industrial Cutting Oil

Member IMC Group  
**icent**  
CNC & VMC Tooling Solutions

**ALFA**  
BIMETAL BANDSAW BLADES  
M42 & M51 Grade Bandsaw Blades

**JE JAY ENTERPRISE**  
Partners In Providing Cost Effective Solutions

📍 12/4, Bhaktinagar Station Plot, Rajkot-360 002.

☎ +91 63546 04954/ 97146 77788

✉ jay.ent.pr@gmail.com / manish@jayrjt.com

DRISHY-24



**B. M. Enterprise**  
Partners In Journey Of Excellence

OUR PRODUCT PORTFOLIO INCLUDES

ONE STOP SOLUTION FOR ALL KINDS OF VENTILATION, COMPLETE SAWING, KNURLING, DRILLING & TAPING.



- Bandsaw Blades
- Circular Saw Cutters



- Bandsaw Blades
- Bandsaw Machines



- HSS & M35 Drills
- Center Drills & Endmils



- Bandsaw Machine
- Circular Saw Machines



- Knurling Tools
- Knurling Die



- Industrial Lubricants
- Cutting Oil

📍 "Sureshwar Nivas", 12/4, Bhaktinagar Station Plot, Rajkot -360 002  
☎ +91 99257 12427, +91 63546 04954, ✉ :bmenterpriserjt@gmail.com

DRISHY-24

સરદાર પત્રા

Vardhman Industrial Zone, Plot No-15, S.V. No.-259 B/h-Kothariya Solvet, Kothariya, Rajkot - 360002. Gujarat (India), Call : +91 87994 54774







**SN AUTOMATION**

**Manufacturing & Supplying Of**

- Spring Conveyor
- Magnet Conveyor
- Hinge Belt Conveyor
- Gravity Roller Conveyor
- Scraper Belt Conveyor
- Screw Conveyor
- Truck Loading Conveyor
- Centralized Conveyor
- Mess Belt Conveyor
- PVC Belt Conveyor
- Rubber Belt Conveyor
- S.S Tank

**SN AUTOMATION**

Survey No 17, Plot no 3 And 4,  
Behind Pentagon Forge, Gondal Road NH, Ta - Gondal,  
Dist - Rajkot, AT BHARUDI, Pin-360311

Mob: 99137 39903 , 99254 56848  
E-mail: snautomation@lve.com,  
snautomation.in@gmail.com  
Web: www.snautomation.in



**king**  
PIPES & FITTINGS  
SINCE 1996

27 SAAL SE  
**PIPE KA KING**  
KING PIPES



Plumbing | Drainage | Agriculture | Sanitary

**KING POLYPLAST PVT. LTD.**  
Opp. Taluka Seva Sadan, Rajkot-Jamnagar Old Highway,  
Paddhari - 360 110, Dist. Rajkot, Gujarat (INDIA)  
www.kingpipe.in | info@kingpipes.in



**plasma**  
Nature Grows Naturally



**PLASMA ALLOYS PVT. LTD**

Specialized Ductile Iron Casting Foundry  
With Distinctive Capabilities of  
SiMo, ADI & SSFDI Grades

**Address :**  
Plasma Gate, Plot No. 1,2,3 & 4, Revenue Survey No. 195,  
Shapar - veraval, Taluka : Kotda Sangani, District : Rajkot - 360024  
Email : info@plasmaalloys.com, Web : www.plasmaalloys.com  
Contact : +91 97373 60666 / 82383 17777



**JAY KHODAL**  
METAL

Mfg. of Zinc Die Casting

**Product Range**

- Zinc die casting
- Customized Components in zinc
- Cnc turned components in zinc
- Cnc Turned + Plating components
- Auto parts in zinc diecast components



5 - Mira Udhyog, Rajkot - 360003  
+91 9998506415  
info@jaykhodalmetal.com  
www.jaykhodalmetal.com



ISO 9001 - 2015 | PED and AD2000 Merkblatt WO | LR Marine | IBR Approved Company



- INVESTMENT CASTINGS
- LOST WAX CASTINGS
- FEINGUSS
- MICROFUSIONES



**SIDDHI**  
CAST PVT. LTD.  
Manufacturers & Exporters of  
INVESTMENT CASTING

**FACTORY :**

Survey No. 53, Opp. Vandheshwar Temple, N. H. No. 27, **At. HADAMTALA**,  
Tal. Kotda Sangani. P.O. Box No. 32, Gondal-360 311. Dist. Rajkot. (Gujarat) India.  
Cell : +91 95373 99899, +91 9712987870 (MKTG)

**REG. OFF. :**

Shyam Arcade, Opp. Shyam Wadi, 17/2, Station Plot, P. O. Box No. 32,  
Gondal-360 311. Dist. : Rajkot. (Gujarat) India.

E - [info@siddhicast.com](mailto:info@siddhicast.com)

W - [www.siddhicast.com](http://www.siddhicast.com)

*Enjoying joy of blending "Green Technology" with Casting...*

**KIC**  
A Mark of Quality  
AN ISO 9001:2015 COMPANY  
**KHODIYAR**  
INDUSTRIAL PVT. LTD.  
BELT CONVEYOR ROLLER, IDLERS & GEAR BOX

MANUFACTURER OF CONVEYOR BELT AND CONVEYOR IDLERS

Plot No. 456 to 4604, Golden Green Industrial City, Mavdi-Pal Road,  
Near Makhwad Chowk, Village-Khanbha, Tal- Lodhika, Khambha,  
RAJKOT. Gujarat - 360311 (India) Mo. : 96875 67045

info@kic.co.in www.kic.co.in / www.kicindia.in

**AAI SHREE KHODIYAR**  
TRUST IN THE NAME  
Since 1996  
ISO 9001:2015 REGISTERED CERTIFIED COMPANY  
**Aai Shree KHODIYAR ROADWAYS**  
(CERTIFIED COMPANY)  
(ISO 9001:2015 REGISTERED CERTIFIED COMPANY)

**BETTER FOR SPECIAL EXPORT CONSIGNMENT**

AMD ICD  
AMD AIR PORT  
KANDLA PORT  
MUNDRA PORT

J.N.P.T. PORT  
NHAVA SHEVA  
DRONAGIRI  
SAHARA CARGO (ANDHERI)

**CORPORATE OFFICE**  
Power Industrial, R.S.No-250, Plot No-38+39/2-Shed No.1,  
Kothariya Solvant, Rajkot - 360022.  
Contact Us :-  
+91 971-425-8789 +91 957-439-9909  
VISIT US at : [www.askrgroup.com](http://www.askrgroup.com) MAIL US at : [askhodiyaaroad@gmail.com](mailto:askhodiyaaroad@gmail.com)

સરદાર પતરા

Vardhman Industrial Zone, Plot No-15, S.V. No.-259 B/h-Kothariya Solvet,  
Kothariya, Rajkot - 360002. Gujarat (India), Call : +91 87994 54774



# Business Insurance



Smart way to save Tax & Take Growth on Tax

Organization that can take advantage



01 **Public Limited Company**



02 **Private Limited Company**



03 **Limited Liability Partnership**



04 **Partnership Firm**



05 **Proprietorship Firm**



06 **Trust Societies & Others**

Let's Understand

Note : The below individuals will not be considered as an employee of the organisation:

Proprietor of a proprietorship Firm | Partners in a Partnership/LLP

Contractual Employees | Trustee of a Trust

## Types Of Business Insurance

■ **Keyman** ■ **Partnership Insurance**

■ **Employer - Employee**

No Impact of Budget '23 - As **Business Insurance** Remains outside the Scope of 10 - 10(d)

Premium paid is **Business expenses** under section 37(1) of Income Tax Act, 1961

**Ex -gratia /** compensation given to deceased employee's legal heir is tax free in the hands of family (as per CBDT Circular 573)

FIKAR  
**FREE** Life

Contact : **Anika Sangghvi M. +91 98339 77000**

સરદાર પત્ર

Vardhman Industrial Zone, Plot No-15, S.V. No.-259 B/h-Kothariya Solvet,  
Kothariya, Rajkot - 360002. Gujarat (India), Call : +91 87994 54774

SARDAR  
INSURANCE





## RAJKOT ENGINEERING ASSOCIATION

### REAના સભ્યોની સવલત અંગેની ઉપલબ્ધતાઓ

1. એકસપોર્ટર માટે સર્ટીફિકેટ ઓફ ઓરીજીન ચાર્જ રૂ. 130/- પ્રતિ સર્ટીફિકેટની સવલત.
2. ઓડીટરીયમની સવલતો
  - A.C. કોનક્રીટ રૂમ ૫૦ ની બેઠક સાથે.
  - A.C. બોર્ડ રૂમ ૫૦ ની બેઠક સાથે.
  - A.C. ઓડિટરીયમ ૩૩૦ ની બેઠક સાથે.
  - LED TV / અલ્ટ્રા મોડર્ન સાઉન્ડ સીસ્ટમ, મોટોરાઈઝડ સ્ક્રીન, પ્રોજેક્ટર તથા લેપટોપ સાથેની સવલત.
3. વિડીયો કોનફરન્સીંગ ફેસેલીટી જેમાં ૨૫ સીટીંગ કેપેસિટીની સવલત.
૪. લાયબ્રેરી : ટેકનિકલ, નોન ટેકનિકલ બુક્સ સાથેની અદ્યતન સુવિધા સાથેની લાયબ્રેરી.

ભવિનનગર ઈન્ડ. એસ્ટેટ ગ્રુ.આ.ડી.સી.,  
શેરી નં.-૩, સપ્લાય.  
Mo. 99132 14935 / Email : info@reaindia.com



### ONE STOP SOURCING SOLUTION FOR COPPER ALLOYS PRODUCTS

#### RANGE OF PRODUCT:



Lead Free Brass Wires



Bronze Wire



Copper & Copper Alloy Wires



Round Rods



Ingots

#### BRONZE FASTENERS:



#### NON FERROUS CASTING & FORGING PARTS



#### JP Copper Alloys

Regd. Office: Plot No. 1, Survey No. 176, Air & Post, Mahiyu,

Mr. Chaur Patel Pump, Ta. Pakhraj, Dist. Rajkot - 360002 (Gujarat) INDIA.

Branch Office: South 80A - Talimbar, 920 Feet Ring Road, Near Baidaj Hall,

Rajkot - 360002 (Gujarat) INDIA.

+91 90274 5076 / 90282 2088

+91 97200 2995

jpcooper@276@gmail.com

www.jpcooper.com



Manufacturer & Exporters of Copper Alloys Ingot, Rod, Tube, Coil, Fasteners & etc.

AN ISO 9001:2015 CERTIFIED COMPANY

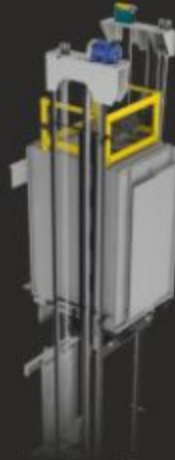

**WHY** CHOOSE US  
What Sets **Express** Electro Elevators Co. Apart?

**28+**  
Years of Experience

**282+**  
Skilled Team

**34752+**  
Installations

**3143+**  
Happy Client



**Express**  
Electro Elevators Co.

103/104. "CENTER ONE", Nr. Wochardt Hospital,  
Kalawad Road, Rajkot.

0281 - 2573053

97240 92366

express\_elevators@yahoo.com

expresselevators.info

**MRL**  
ELEVATOR

No more  
machine room  
and more  
space saving



**Express**  
Electro Elevators Pvt. Ltd.

103/104. "Center One", Nr. Wochardt Hospital,  
Kalawad Road, Rajkot - 360 005.  
Phone : 0281 - 2573053.

Mobile : +91 97240 92366 (Sales Inquiry)

E-mail : salesmanager@expresselevators.info

Website : www.expresselevators.info

સરદાર પત્ર

Vardhman Industrial Zone, Plot No-15, S.V. No.-259 B/h-Kothariya Solvet,  
Kothariya, Rajkot - 360002. Gujarat (India), Call : +91 87994 54774

**SARDAR**  
PAPER



# RAJKOT ENGINEERING ASSOCIATION

## REANA સભ્યોની સવલત અંગેની ઉપલબ્ધતાઓ

૧. એક્સપોર્ટર માટે સર્ટીફિકેટ ઓફ ઓરીજન ચાર્જ રૂ. ૧૩૦/- પ્રતિ સર્ટીફિકેટની સવલત.
૨. ઓડિટરીયમની સવલતો
  - A.C. કોન્ફરન્સ રૂમ ૫૦ ની બેઠક સાથે.
  - A.C. બોર્ડ રૂમ ૫૦ ની બેઠક સાથે.
  - A.C. ઓડિટરીયમ ૩૩૦ ની બેઠક સાથે.
  - LED TV / અલ્ટ્રા મોર્ડન સાઉન્ડ સીસ્ટમ, મોટોરાઈઝડ સ્ક્રીન, પ્રોજેક્ટર તથા લેપટોપ સાથેની સવલત.
૩. વિડીયો કોન્ફરન્સીંગ ફેસેલીટી જેમાં ૨૫ સીટીંગ કેપેસિટીની સવલત.
૪. લાયબ્રેરી : ટેકનિકલ, નોન ટેકનિકલ બુક્સ સાથેની અદ્યતન સુવિધા સાથેની લાયબ્રેરી.

ભક્તિનગર ઈન્ડ. એસ્ટેટ જી.આ.ડી.સી.,

શેરી નં.-૩, રાજકોટ.

Mo. 99132 14935 / Email : info@reaindia.com



સરદાર પત્ર

Vardhman Industrial Zone, Plot No-15, S.V. No.-259 B/h-Kothariya Solvet,  
Kothariya, Rajkot - 360002. Gujarat (India), Call : +91 87994 54774

SARDAR  
Engineering & Technology





## RAJKOT ENGINEERING ASSOCIATION

# DIRECTORY 2024-2025 & BULLETIN RATES

SR. NO.	ADVERTISEMENT TYPE	DIRECTORY SIZE & CM (W X H)	BULLETIN SIZE IN CM (W X H)	DIRECTORY RATE	BULLETIN RATE <small>April 24 to March 26</small>
---------	--------------------	-----------------------------	-----------------------------	----------------	--

### PREMIUM SECTION

1	BACK PAGE	15 x 23	20 x 26	185000	150000
2	FIRST PAGE INNER	15 x 23	20 x 26	115000	140000
3	BACK PAGE INNER	15 x 23	20 x 26	99000	125000
4	ALL PAGE BOTTOM LINE STRIP	1 line + logo	1 line + logo	99000	80000
5	OPP. FIRST PAGE INNER	13.25 x 21	-	60000	-
6	OPP. BACK PAGE INNER	13.25 x 21	-	40000	-
7	FULL FLIP PAGE	27 x 23	37 x 26	90000	220000
8	HALF FLIP PAGE	21 x 23 + 6x23	20x26 + 10x26	60000	115000
9	POINTER FULL PAGE	13.25 x 21	-	45000	-
10	TAG - BOOKMARK	7 x 15	-	50000	-
11	PREMIUM FULL PAGE COLOR	13.25 x 21	-	35000	-
12	PREMIUM FULL PAGE + PROFILE	13.25 x 21	-	50000	-

### COLOR SECTION

1	PIN PAGE (2 PAGE)	13.25 X 21	18 x 24	50000	125000
2	FULL PAGE + PROFILE	13.25 X 21	18 x 24	45000	110000
3	FULL PAGE COLOR	13.25 X 21	18 x 24	28000	75000
4	HALF PAGE COLOR	13.25 X 10.25	18 x 12	16000	40000
5	QUARTER PAGE COLOR	6.5 X 10.25	9 x 12	10000	27000

### B/W SECTION

1	PIN PAGE (2 PAGE)	-	18 X 24	-	75000
2	FULL PAGE + PROFILE B/W	-	18 X 24	-	60000
3	FULL PAGE B/W	-	18 X 24	-	40000
4	HALF PAGE B/W	-	18 X 12	-	27000
5	QUARTER PAGE B/W	-	9 X 12	-	15000

#### બુલેટીન જાહેરાત માટેની અક્ષત્વની સુચનાઓ :

- જાહેરાત સંપર્ક માટે "ગુજરાત એન્ડ એન્ડ મીડિયા" ના મો. ૯૩૩૩૩ ૯૩૩૭૫ પર કરવાનો રહેશે.
- પેમેન્ટ "રાજકોટ એન્જીનીયરીંગ એસોસીએશન" Payable at per Rajkot નો ચેક/ડી.ડી. થી આપવાનો રહેશે.
- જાહેરાત પસંદગીની જગ્યા પહેલા તે પહેલાના ધોરણે આપવામાં આવશે.



## સંસ્થા સમાચાર

### ❖ શ્રમ અને રોજગાર મિનિસ્ટર ને પત્ર મોકલાવેલ :

તા. ૧૭ થી ૨૧ જાન્યુઆરી ૨૦૨૫ દરમિયાન દિલ્હીમાં યશોભૂમિ ક્ષારકામાં યોજાયેલ ભારત મોબીલીટી એક્ષ્પોની મુલાકાત માટે માનનીય મંત્રી ડો મનસુખભાઈ માંડવીયા (શ્રમ અને રોજગાર મિનિસ્ટર), શ્રી પિયુષ ગોયલ (કોમર્સ અને ઈન્ડસ્ટ્રીઝ મિનિસ્ટર), શ્રી નિતિન ગડકરી (રોડ ટ્રાન્સપોર્ટેશન અને હાઇવે મિનિસ્ટર) વિગેરે મંત્રીશ્રીઓને ભારત મોબીલીટી એક્ષ્પોની મુલાકાત માટેનો પત્ર તા. ૧૧-૦૧-૨૦૨૫ ના રોજ ઇમેલ દ્વારા મોકલાવેલ.

### ❖ રાજકોટ એન્જી. ઈન્ફો. બુલેટીન આર.એમ.એસ. દ્વારા મોકલાવેલ :

આર.ઈ.એ. નું માહે જાન્યુઆરી-૨૦૨૫ નું બુલેટીન પોસ્ટ ખાતાના આર.એમ.એસ. દ્વારા તા. ૧૮-૦૧-૨૦૨૫ ના રોજ સભ્યો ને મોકલાવામાં આવેલ.

આર.ઈ.એ.નું માહે જાન્યુઆરી-૨૦૨૫ ના બુલેટીનની લિન્ક તા. ૨૦-૦૧-૨૦૨૫ ના સભ્યોને મોકલવામાં આવેલ.

### ❖ બોર્ડ ઓફ ડાયરેક્ટરને પરિપત્ર મોકલાવેલ :

૭૬માં પ્રજાસત્તાક દિવસ નિમિત્તે યોજાયેલ ધ્વજવંદન કાર્યક્રમ અંગેની માહિતી તા. ૨૪-૦૧-૨૦૨૫ ના રોજ મોકલાવેલ.





## કાર્ય સારાંશ

### ❖ ભારત મોબિલીટી ગ્લોબ એક્ષ્પો.



વિશ્વ વિખ્યાત ઓટો એક્ષ્પો જે ભારત મોબિલીટી એક્ષ્પોના બેનર હેઠળ તા. ૧૭ થી ૨૧ જાન્યુઆરી ૨૦૨૫ દરમિયાન દિલ્હીમાં યશભૂમિ દ્વારકામાં યોજાયો. આ એક્ષ્પોમાં રાજકોટના ૫૦ થી વધારે ઓટોપાર્ટ્સ ઉત્પાદન કરતાં યુનિટો એ ભાગ લીધો અને પ્રદર્શનમાં પોતાની પ્રોડક્ટ ડિસ્પ્લે કરી જેમાં રાજકોટ એન્જીનિયરિંગ એસોસિએશનનું સૌથી મોટું ૧૧૦૦ સ્કવેર મીટર થી વધારે રો-સ્પેસનું પેવેલિયન બનાવવામાં આવ્યું હતું. રાજકોટ કલ્ચરને નવી ઓળખ આપવાનું અને વિશ્વનું ઓટો પાર્ટ્સ ઉત્પાદન કરતું હબ બનાવવા માટે રાજકોટ એન્જીનિયરિંગ એસોસિએશન દ્વારા આ પ્રયત્ન કરવામાં આવ્યો જેના હિસાબે રાજકોટને ૩૦૦ કરોડથી વધારેનો બિઝનેસ મળશે આવો અંદાજ છે આના હિસાબે રાજકોટના આ યુનિટોથી ૨૦૦૦ થી વધારે માણસોને રોજગારી મળવાનો અંદાજ છે રાજકોટના આ ઉદ્યોગકારોના ઉત્સાહમાં વધારો કરવા માટે માનનીય કેન્દ્રિય મંત્રી ડો. મનસુખભાઈ માંડવીયા (શ્રમ અને રોજગાર મિનિસ્ટર) દ્વારા એક રાત્રી ભોજનનું આયોજન કર્યું હતું અને બધા ઉદ્યોગકારો સાથે વિસ્તારથી ચર્ચા કરી દેશના વિકાસને આગળ વધારવા માટેના વિચારોનું યોગદાન આપવામાં આવ્યું. મંત્રીશ્રી ના આવા આયોજનથી ઉદ્યોગકારોનો સરકાર ઉપરના વિશ્વાસમાં ખૂબ જ વધારો થયો તેમજ ખૂબ હર્ષની લાગણી અનુભવી વધારામાં ડો. મનસુખભાઈ માંડવીયાએ બીજા દિવસે પ્રદર્શનની મુલાકાત લઈને રાજકોટના બધાજ સ્ટોલ ધારકોને મળીને ઉદ્યોગકારોને પ્રોત્સાહિત કર્યા હતા મંત્રીશ્રીના આવા પ્રોત્સાહનની બધાએ નોંધ લીધી હતી. આ પ્રસંગે રાજકોટ એન્જીનિયરિંગ એસોસિએશનના પ્રમુખશ્રી નરેન્દ્રભાઈ પાંચાણીએ મંત્રી સાહેબ સાથે રહી મંત્રીશ્રીનો હૃદયથી આભાર માન્યો હતો રાજકોટ એન્જીનિયરિંગ એસોસિએશનના જોયન્ટ સેક્રેટરી શ્રી ચંદ્રેશભાઈ પટેલ દ્વારા પેવેલિયનના નિર્માણ માટે ત્રણ દિવસ વહેલા દિલ્હી જઈને પેવેલિયનના નિર્માણ માટે અમૂલ્ય યોગદાન આપવામાં આવ્યું હતું તેમજ ડાયરેક્ટર શ્રી સંજીવભાઈ વાડોદરીયા, નૈષઠભાઈ કોરાટ, સમીરભાઈ વૈષ્ણવ, આશિષભાઈ સરઘારાએ પ્રદર્શનની મુલાકાત લીધેલ તેમજ આ તકે શ્રી ચંદ્રેશભાઈના આ સફળ ઈવેન્ટ માટે બીરદાવેલ. રાજકોટ એન્જીનિયરિંગ એસોસિએશનના આ પેવેલિયન થકી રાજકોટના ઉદ્યોગકારોને વિશ્વ ક્લક ઉપર પહોંચવા તેમજ ટ્રેડ ડેવલોપમેન્ટ માટે એક ઉમદા પ્લેટફોર્મ તૈયાર કર્યું.







ડો. મનસુખભાઈ માંડવીયાએ પ્રદર્શનની મુલાકાત લઈને રાજકોટના બધાજ સ્ટોલ ધારકોને મળીને ઉદ્યોગકારોને પ્રોત્સાહિત કર્યા હતા.





ડો. મનસુખભાઈ માંડવીયાએ પ્રદર્શનની મુલાકાત દરમિયાન રાજકોટ એન્જીનીયરીંગ એસોસીએશનના પ્રમુખશ્રી તેમજ પૂર્વ પ્રમુખશ્રી પરેશ વાસાણી દ્રશ્યમાન થાય છે.







❖ ૭૬ માં પ્રજાસત્તાક દિવસની ઉજવણી





#### ❖ રાજકોટ એન્જીનીયરીંગ એસોસીએશનની ૭૬માં પ્રજાસત્તાક દિવસની ઉજવણી

રાજકોટ એન્જીનીયરીંગ એસોસીએશન ખાતે ભારતના ૭૬માં પ્રજાસત્તાક પર્યની ઉજવણી તા. ૨૬-૦૧-૨૦૨૫ ના રોજ સવારના ૯.૦૦ વાગ્યે આર.ઈ.એ.ના પ્રમુખ શ્રી નરેન્દ્ર પાંચાણીના અધ્યક્ષ સ્થાને યોજવામાં આવેલ. આ પ્રજાસત્તાક દિન પ્રસંગે નિયત સમયે સંસ્થાના પ્રમુખશ્રીએ બહોળી સંખ્યામાં લોકોની હાજરી વચ્ચે રાષ્ટ્રીય ત્રિરંગાને સલામી આપેલ. પ્રજાસત્તાક પર્યના ઉત્સવની ઉજવણીમાં આર.ઈ.એ. ના બોર્ડઓફ ડાયરેક્ટરશ્રીઓ, સભ્યશ્રીઓ, સી.આઈ.આઈ. ના પ્રતિનિધિઓ, આઈ.આઈ.એફ. પ્રતિનિધિઓ, સર્વે અધિકારીગણ અને આર.ઈ.એ. તથા ઉદ્યોગ સાહસિકોના પરિવારની ઉત્સાહભરે ઉપસ્થિત રહેલ. શ્રી જીજ્ઞેશ આરોજાં (ઉપપ્રમુખશ્રી), શ્રી વિનોદ આસોદરીયા (માનદ મંત્રીશ્રી), શ્રી આશિષ સરધારા (કોષાધ્યક્ષ) તેમજ મહેમાનશ્રીઓ ઉપસ્થિત રહેલ. આ ગણતંત્ર પર્યના ઉત્સવની ઉજવણીમાં આર.ઈ.એ.ના સમગ્ર બોર્ડઓફ ડાયરેક્ટરશ્રીઓ, સભ્યશ્રીઓ તથા સર્વે અધિકારીગણ અને સ્ટાફગણ બહોળી સંખ્યામાં ઉપસ્થિત રહેલ. વિશેષમાં આર.સી.સી.આઈ. ના ઉપપ્રમુખ શ્રી પાર્થ ગણાત્રા, શ્રી નરેશ શેઠ - આજી જીઆઈડીસીના પ્રમુખશ્રી તેમજ નિમંત્રીત અગ્રણીશ્રીઓની વિશેષ ઉપસ્થિતિ રહેલ. આ પ્રસંગે પ્રમુખ શ્રી નરેન્દ્ર પાંચાણીએ વિશેષમાં ઉદ્યોગ-ધંધા ક્ષેત્રે સ્ત્રી સશક્તિકરણની પ્રેરણારૂપ આજના આ શુભ દિવસે વ્યવસાયના વિકાસ માટે ફિમેલ મોટીવેશનલ પ્રોગ્રામ રાખવામાં આવેલ. જેમાં મોટીવેશનલ ઈન્ડસ્ટ્રીઝ ટ્રેઇનર સુશ્રી વૈશાલીબેન પારેખ દ્વારા વ્યવસાયના વિકાસમાં રસ ધારાવનાર મહિલાઓને માગદર્શન આપવામાં આવેલ. જેમાં મોટી સંખ્યામાં મહિલાઓએ ભાગ લીધેલ. પ્રમુખ શ્રી નરેન્દ્ર પાંચાણીએ આવા હવે પછીના કાર્યક્રમમાં એસોસીએશનના વધુને વધુ સભ્યો રાષ્ટ્રીય પર્યમાં જોડાય એવા પ્રયાસ કરવા અંગેનું સૂચન કરેલ.

#### ❖ માહે જાન્યુઆરી-૨૦૨૫ ની બોર્ડ ઓફ ડાયરેક્ટરની મીટીંગ મળેલ :

આર.ઈ.એ. ની માહે જાન્યુઆરી-૨૦૨૫ ની બોર્ડ ઓફ ડાયરેક્ટરની મીટીંગ પ્રમુખ શ્રી નરેન્દ્ર પાંચાણીના અધ્યક્ષ સ્થાને તા. ૨૮-૦૧-૨૦૨૫ ના રોજ સાંજના ૬-૦૦ કલાકે બોર્ડરૂમમાં મળેલ મીટીંગના એજન્ડા મુજબ તા. ૨૩-૧૨-૨૦૨૪ ની ગત મીટીંગની કાર્યવાહી નોંધ વાંચી સંભળાવવામાં આવેલ જેને સર્વાનુમતે મંજૂર રાખવાનું ઠરાવવામાં આવેલ. એજન્ડા મુજબના મુદ્દાઓની વિસ્તૃત ચર્ચા વિચારણા કરવામાં આવેલ જેને સર્વાનુમતે બહાલ રાખવાનું ઠરાવવામાં આવેલ.





## ચાલો, ભારતને આધુનિક ટેકનોલોજી રાષ્ટ્ર બનાવીએ : બજેટ ૨૦૨૫ અને સરકારની પ્રોત્સાહક સ્ટાર્ટઅપ સપોર્ટ નીતીઓ : સ્વદેશી વિકાસ તરફ એક મજબૂત કદમ

હમણાંજ યુનિયન બજેટ ૨૦૨૫ આવ્યું છે. જે નાણાં મંત્રી શ્રીમતિ નિર્મલા સીતારમણે રજૂ કર્યું છે. આજના લેખમાં, આપણે સ્ટાર્ટઅપ અને ટેકનોલોજી ક્ષેત્રે થયેલા નવા ફેરફારો અને પ્રોત્સાહનોને સમજવાનો પ્રયાસ કરીએ. અગાઉના લેખોમાં આપણે જોયું કે ભારત ટેકનોલોજી અને ઈનોવેશનના માધ્યમથી એક સ્વદેશી ટેકનોલોજી રાષ્ટ્ર બની રહ્યું છે. તો, આ બજેટમાં આ દિશામાં શું નવું છે અને અગાઉની કઈ સ્કીમો ઉપલબ્ધ છે, તે જાણવાનો પ્રયાસ કરીએ.

\* ૨૦૨૫ ના યુનિયન બજેટમાં સ્ટાર્ટઅપ માટે નવા મુખ્ય પ્રોત્સાહનો અને સુધારાઓ :

- \* રૂ. ૧૦,૦૦૦ કરોડ રૂપિયાનું ફંડ ઓફ ફંડ્સ : જે સ્ટાર્ટઅપ્સ માટે વેન્યર કેપિટલ (VC Fund) રોકાણને વધુ પ્રોત્સાહન આપશે. આ ફંડ દ્વારા, સિડબી અને સેબી રજિસ્ટર્ડ AIF (Alternate Investment Funds) રૂ. ૧.૫ લાખ કરોડ રૂપિયાનું વધુ રોકાણ ઉભું કરી શકશે.
- \* Section 80-IAC સ્કીમ ઘણા સમયથી હતી જ, જેને વધુ પાંચ વર્ષ માટે લંબાવી દેવામાં આવી છે. આ સ્કીમ હેઠળ જે સ્ટાર્ટઅપની વાર્ષિક આવક રૂ. ૧૦૦ કરોડથી ઓછી હોય તેમણે શરૂઆતના ૧૦ વર્ષ ના સમયગાળામાં કોઈપણ ૩ વર્ષ દરમિયાન પ્રોફિટ પર ૧૦૦% ટેક્સ છુટ આપવામાં આવે છે. હવે આ સ્કીમ ૧-લી એપ્રિલ ૨૦૩૦ સુધી લંબાવવામાં આવી છે.
- \* સ્ટાર્ટઅપ્સ માટે કેડિટ ગેરંટી રૂ. ૧૦ કરોડથી વધારીને રૂ. ૨૦ કરોડ કરવામાં આવી છે.
- \* મહિલાઓ, એસસી (SC) અને એસટી (ST) ઉદ્યોગ સાહસિકોને ૫ લાખ સુધી ટર્મ લોન મળશે.
- \* રૂ. ૫૦,૦૦૦ અટલ ટિકરિંગ લેવ્સ (ATL) અને એઆઈ સેન્ટર ઓફ એક્સલન્સ (AI CoE) સ્થાપિત કરવા માટે રૂ. ૫૦૦ કરોડનું ફંડ આપવામાં આવ્યું છે.

આ બધા સુધારા અને આર્થિક સહાયને કારણે નાના, મધ્યમ અને ટેકનોલોજી ક્ષેત્રમાં કામ કરી રહેલા ઈનોવેટીવ સ્ટાર્ટઅપને વધુ ફાયદો થશે. જેનાથી ભારતના યુવાનો માટે નવી ટેકનોલોજી અને ઈનોવેટિવ પ્રોડક્ટને લઈ આવવાનો માર્ગ સરળ બનશે.

ભારત સરકાર સ્ટાર્ટઅપ માટે ઘણા સમયથી ઘણા બધા પ્રોત્સાહનો અને સ્ટાર્ટઅપ ગ્રાન્ટ્સ આપી રહી છે. ચાલો સ્ટાર્ટઅપ ગ્રાન્ટ્સને થોડું સમજીએ. સ્ટાર્ટઅપ ગ્રાન્ટ એ શરૂઆતના તબક્કાના વ્યવસાયોને તેમના વિકાસ અને નવીનતા માટે આપવામાં આવતી આર્થિક સહાયનો એક પ્રકાર છે. બેંકમાંથી મળતી લોનની ચુકવણી કરવી પડે છે જ્યારે, ગ્રાન્ટ્સની ચુકવણી કરવાની જરૂર હોતી નથી.

સ્ટાર્ટઅપ ગ્રાન્ટ્સ નવા વ્યવસાયોને પ્રારંભિક આર્થિક અડચણો દુર કરવાં મહત્વપૂર્ણ ભૂમિકા ભજવે છે. જે તેમને સંશોધન અને વિકાસ, સાધનોની ખરીદી, કુશળ પ્રોપેશનલ્સને નિયુક્ત કરવા વગેરે બાબતોમાં મદદરૂપ થાય છે.

ભારત સરકાર અને વિવિધ રાજ્ય સરકારો ઉદ્યોગસાહસિકતા અને ઔદ્યોગિક વિકાસને પ્રોત્સાહન આપવા માટે અનેક ગ્રાન્ટ યોજનાઓ ઓફર કરે છે. કેટલીક નોંધપાત્ર સ્ટાર્ટઅપ સંબંધિત યોજનાઓ નીચે મુજબ છે.

- \* સ્ટાર્ટઅપ ઈન્ડિયા સીડ ફંડ સ્કીમ (SISFS) પ્રારંભિક તબક્કાના સ્ટાર્ટઅપ્સને ઉત્પાદન વિકાસ, પ્રોટો ટાઇપ (POC/MVP) માટે રૂ. ૫૦ લાખ સુધી આર્થિક સહાય પ્રદાન કરે છે.
- \* એમએસએમઈ ઈનોવેશન સ્કીમ માઈક્રો, સ્મોલ અને મીડિયમ એન્ટરપ્રાઇઝેસ (MSMEs) ને ટેકનોલોજીકલ ઈનોવેશન અને વિકાસમાં રૂ. ૧૫ લાખ સુધી મદદ કરે છે.
- \* નેશનલ ઈનિશિએટિવ ફોર ડેવલપિંગ એન્ડ હાર્નેસિંગ ઈનોવેશન્સ (NIDHI) : ઈન્ક્યુબેશન સેન્ટર્સ દ્વારા ઈનોવેશન્સ અને સ્ટાર્ટઅપ્સને પ્રોત્સાહન આપવામાં રૂ. ૧૦ લાખ સુધી મદદ કરે છે.
- \* TIDE 2.0 (ટેકનોલોજી ઈન્ક્યુબેશન એન્ડ ડેવલપમેન્ટ ઓફ એન્ટરપ્રેન્યોર્સ) : ટેકનોલોજી આધારિત સ્ટાર્ટઅપ્સ માટે રૂ. ૪૦ લાખ સુધી મદદ કરે છે.

**ગુજરાત રાજ્ય સરકાર ગ્રાન્ટ્સ**

ગુજરાતને ૨૦૧૮ થી The Department for Promotion of Industry and Internal Trade (DPIIT) દ્વારા 'બેસ્ટ પર્ફોર્મર રાજ્ય' નો એવોર્ડ સ્ટાર્ટઅપને સપોર્ટ કરવા માટે મળી રહ્યો છે. રાજ્ય સરકાર પાસે પોતાની અલગથી ગ્રાન્ટ અને સ્કીમો છે. એમાંથી થોડી વિગતો નીચે મુજબ છે.

- \* સ્ટાર્ટઅપ ગુજરાત સ્કીમ : ગુજરાતમાં રજિસ્ટર્ડ સ્ટાર્ટઅપ્સ માટે ઈન્ક્યુબેશન સપોર્ટ હેઠળ રૂ. ૩૦ લાખ સુધી, અને અમુક સ્પેશિયલ સ્ટાર્ટઅપ માટે રૂ. ૪૦ લાખ સુધીની ગ્રાન્ટ મળે છે.
- \* સ્ટુડન્ટ સ્ટાર્ટઅપ એન્ડ ઈનોવેશન પોલિસી (SSIP 2.0) વિદ્યાર્થીઓ અને યુવા ઉદ્યોગ સાહસિકોને શરૂઆતમાં પોતાના આઈડિયા પર કામ કરવા માટે રૂ. ૨ લાખ સુધી મદદ કરે છે.

ગુજરાત યુનિવર્સિટી સ્ટાર્ટઅપ એન્ડ એન્ટરપ્રેન્યોરશિપ કાઉન્સિલ (GUSEC)( <https://gusec.edu.in/>) i-Hub (<https://ihubgujarat.in/>) અને (<https://www.icreate.org.in/>) જેવી ઘણી સંસ્થાઓ પણ ગુજરાતમાં સ્ટાર્ટઅપ્સ માટે એક્સપર્ટ માર્ગદર્શન, ટેકનોલોજી સપોર્ટ, કામ કરવા માટે Co-Working Space અને ગ્રાન્ટ સહાય આપે છે.

**રાજકોટમાં યુનિવર્સિટી ઈન્ક્યુબેશન પ્રોગ્રામ્સ**

રાજકોટની શૈક્ષણિક સંસ્થાઓ ઈન્ક્યુબેશન સેન્ટર્સ દ્વારા સ્ટાર્ટઅપને માર્ગદર્શન આપવામાં મહત્વપૂર્ણ ભૂમિકા ભજવે છે. રાજકોટમાં નીચે મુજબ કોલેજો પાસેથી ઈન્ક્યુબેશન સપોર્ટ લઈ શકાય છે.

- \* સૌરાષ્ટ્ર યુનિવર્સિટી-ઈન્ક્યુબેશન સેન્ટર
- \* ગવર્નમેન્ટ ઈજનેરીંગ કોલેજ, રાજકોટ-SSIP પ્રી-ઈન્ક્યુબેશન સેન્ટર
- \* મારવાડી યુનિવર્સિટી ઈનોવેશન અને ઈન્ક્યુબેશન રિસર્ચ સેન્ટર (MUIIR)
- \* આરકે યુનિવર્સિટી - K S Patel Centre for Entrepreneurship (KSPCFE)
- \* આત્મીય યુનિવર્સિટી ઈન્ક્યુબેશન સેન્ટર

આ યુનિવર્સિટી-લેડ ઈન્ક્યુબેશન પ્રોગ્રામ્સ કોલેજના ભણતરની સાથે ઉદ્યોગ સાહસિકતા અને તમારા આઈડિયા ને એક વ્યવસાયિક બિઝનેસ માં કેવી રીતે રૂપાંતરિત કરવું એ માટેનો જરૂરી સપોર્ટ ,માર્ગદર્શન અને સાધનો પુરા પાડે છે.

આગામી લેખમાં, આપણે રાજકોટ અને ગુજરાતના સ્ટાર્ટઅપ ઈકોસિસ્ટમ સ્થિતિને વધુ ઉંડાણપૂર્વક જોઈશું.

જય હિન્દ, જય ભારત !

રવિન ભાડજા

Founder & CEO - M/s. RB Corporation Group  
(Find Me Factory)  
ravn@findmefactory.com

**લેખકનો પરિચય :** તેઓ એક સફળ ઉદ્યોગ સાહસિક છે. તેઓ મેન્યુફેક્ચરિંગ, એગ્રીટિક, સસ્ટેનેબિલિટી, સ્માર્ટ ફેક્ટરી અને એરોસ્પેસ ઉદ્યોગમાં એન્જિનીયરીંગ અને મેનેજમેન્ટ પ્રોફેશનલ તરીકે બે દાયકાથી વધુ નો અનુભવ ધરાવે છે. તેઓ વૈશ્વિક કંપનીઓ સાથે આધુનિક ટેકનોલોજી ધરાવતી પ્રોડક્ટ ની ડિઝાઈન, ડેવલપમેન્ટ અને પ્રોડક્શનના દરેક તબક્કામાં કામ કરે છે. તેઓ સ્ટાર્ટઅપ્સ એમ.એસ.એમ.ઈ. ને ટેકો આપવા માટે ગવર્નમેન્ટ અને વિવિધ યુનિવર્સિટી, ઈન્ક્યુબેશન સેન્ટર સાથે ઉદ્યોગ નિષ્ણાંત તરીકે સેવા આપે છે. તેમની કંપની [www.findmefactory.com](http://www.findmefactory.com) ઈનોવેશન, મેન્યુફેક્ચરિંગ અને તેની સપ્લાય ચેઈનને સરળ અને અસરકારક બનાવવા માટે સતત પ્રયાસ કરે છે, જેથી ભારતની મેન્યુફેક્ચરિંગ ની નાની કંપનીઓ પણ ભવિષ્યમાં આવતી ઈનોવેટિવ પ્રોડક્ટ ના પ્રોડક્શનમાં જોડાઈ શકે.





“આર.ઈ.એ. ના સભ્યો તથા પરિવારગણ માટે મેડીકલ સારવાર માટે એમ.ઓ.યુ. કરેલ”



RAJKOT ENGINEERING ASSOCIATION



A unit of "Shree Giriraj Lifecare Private Limited"

- A. OPD In-house consultation માટે ડીસ્કાઉન્ટ ૨૦%
- B. For Investigation OPD offer 20% discount, For Procedures during OPD Offer 20% Discount
- C. For IP Admissions, Excluding Out sources services, Pharmacy, Cashless Health Insurance services and consumables etc. offer 12% Discount.

નેત્રદીપ આઈ હોસ્પિટલ



- A. IPD માટે સ્પે. ડીસ્કાઉન્ટ ૧૦%
- B. OPD In-house consultation માટે સ્પે. ડીસ્કાઉન્ટ ૫૦%
- C. OPD In-house consultation માટે સ્પે. ડીસ્કાઉન્ટ ૨૦%

સિનર્જી હોસ્પિટલ



- A. OPD In-house consultation માટે સ્પે. ડીસ્કાઉન્ટ ૧૦%
- B. Total hospitalization bill excluding pharmacy, consumables and outsourced services માટે સ્પે. ડીસ્કાઉન્ટ ૧૦%
- C. Health Checkup Package in Hospital માટે સ્પે. ડીસ્કાઉન્ટ ૧૦%
- D. OPD in house investigations માટે સ્પે. ડીસ્કાઉન્ટ ૧૫%



વોકહાર્ટ હોસ્પિટલ

- A. OPD In-house consultation માટે સ્પે. ડીસ્કાઉન્ટ ૨૦%
- B. DIGNOSTICS AND LABORATORY TEST માટે સ્પે. ડીસ્કાઉન્ટ ૨૦%
- C. IPD in house investigations માટે સ્પે. ડીસ્કાઉન્ટ ૧૨%



# FOUNDRY CHEMICALS



## FEEDCHEM

MANUFACTURERS OF FOUNDRY CHEMICALS & COATINGS

### Our Products

- ▶ No Bake Binder Systems
- ▶ Refractory Coatings in Solvent & Water
- ▶ Green Sand Mould Additives
- ▶ Auxiliaries

#### FEEDCHEM (INDIA) PVT. LTD.

 Plot No. 28 to 38, "Gokul Industrial-C"  
Survey No.234 and 256, J K Industrial Zone,  
Village - Piplana, Rajkot-360024, (Gujarat-INDIA)

 [info@feedchem.co.in](mailto:info@feedchem.co.in)  
[www.feedchem.in](http://www.feedchem.in)

 +91 81400 03456





Chirag Shah  
098240 28131

**We are Dealing In :**

IPA (ISO PROPYL ALCOHOL)  
AEROSOL OT (DI OCTYL SODIUM  
SULHOSUCCNATE)  
1 OCTANOL  
MEK (METYL ETHYL KETON)  
PETROLIUM JILLY  
2 ETHYL HEXNOL  
LABORATORY CHEMICALS N GLASS WEAR  
GLASS PARTS OF CARBON SULPHUR  
APPRATUS N CONSUMABLE

**BHUMI  
SCIENTIFIC INC**

Reg. Office : A/7, Sumel Flats, Nr. Shreyash Crossing,  
Ambawadi, Ahmedabad - 380015 INDIA

Office : C-27, Maruti Ind. Estate, Opp. Kirti Tools,  
Ph 1, GIDC Vatva, Ahmedabad - 382445 INDIA



**We Shape Your Imaginations**

We Deliver Results that exceed our client's expectations and we are committed to providing the highest level of customer service

**Our Services**

Precision Patterns For Foundries  
Custom Patterns  
Designing  
Machining  
Casting  
Reverse Engineering

**We Working for**

Valves and Pumps  
Machine Tools  
Textiles  
Marine Parts  
Automotive

**Pattern Material**

Wood  
Aluminium  
Thermocol

**Prasad PATTERN WORKS**

info@prasadpattern.com  
prasadpatternworks@gmail.com  
www.prasadpattern.com

17-Ashapura Nagar, Kothariya Road, Rajkot 2.

Chandresh Bakraniya -91 97142 02314



All Type of  
**CI&SGICasting  
Manufacturing**

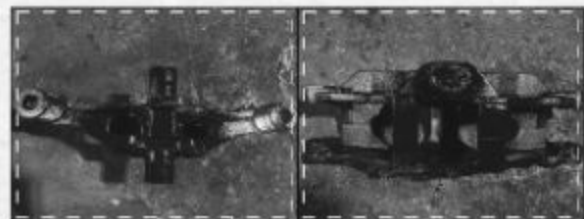

Address : JK Diamond Industrial Area, Survey No.123,  
Plot No. 56/57/58, Lohada, Rajkot, Gujarat - 360002  
Phone No. +91 94272 20481 | + 91 97500 10017  
Email : shivmetal123@hotmail.com



Paresh Rangani  
+91 82645 57951



STEEL  
ALLOY STEEL  
CASTING PARTS

## NEON ENTERPRISE

Address : Mani Nagar-3, Nr. Ashok Garden,  
Mavdi plot, Rajkot - 360004.

Email : neonenterprise93@yahoo.com



## MAA Quality Inspection Services

- **Competent Person under Factory Act**  
Inspection of Hoist and Lifts and Certification in Form No: 09 – LIFT INSPECTION CERTIFICATION
- **Inspection of Lifting Tools and Tackles Certification in Form No: 10 – CHAIN BLOCKS, D SHAKLES, ALL TYPES OF CRANES – EOT, HYDRAULIC MOBILE CRANE, CRAWLER, TOWER CRANE, GANTRY CRANE, HYDRA, FORK LIFT, EYE BOLT, SLING, ELECT HOIST, STACKER, FORK LIFT, WINCH, PLATE CLAMP, MONORAIL, HOOK CHOOK.**
- **Inspection external & internal examination & hydraulic testing of pressure vessels/plants etc and Certification in Form No: 11 – AIR RECEIVER, REACTOR, OIL EXPELLER, PRESSURE VESSEL.**
- **Inspection for Safety against rotating/moving machinery, power presses, Centrifugal Machines, Dangerous Machines and Certification – POWER PRESS, CENTRIFUGAL MACHINE**
- **Inspection of Dust/Fume Extraction/Ventilation System, Dangerous Process, exposure of workman etc. and Certification in Form No: 26A – FOUNDRY PLANT, PAINT SHOP**
  - Chartered Engineer Certification
  - Govt Approved Valuer- Plant and Machinery
  - DISH Approved Safety Training as per requirement
  - Legal Safety Audit as per IS 14489:2018
  - NDT Witness – UT, MPT, RT, LPT
  - Third Party Inspection
  - Thickness mapping of Pipe Line, Vessel, Tank
  - Noise Level and Illumination Level Measurements
  - IMS Co ordination

Address : 621, Unity Plus, Opposite Suvama Bhumi Complex,  
Nana Mova Main Road, Behind Speedwell Party Plot, Rajkot - 360005  
Email : mjis.rajkot@gmail.com Mobile No. : 94279 64701 | 90818 85344

# હિરેન ધારૈયા

## CNC પ્રોગ્રામિંગ ક્લાસિક્સ

# હાર્દિક ધારૈયા

## 95742 61002

# CNC

## પ્રોગ્રામિંગ શીખો

## CNC મશીન ઉપર પ્રેક્ટીકલ સાથે

ISO  
પ્રમાણિત  
સંસ્થા



Centrifugal Mono-block Pump,  
Open-well Pumps,  
V4/V6 Submersible Pump-sets,  
Self Priming Pumps &  
Electric Motors.



Plot No. 150, Dineyay Ind. Estate, Opp. Gamara Hotel,  
N.H.8-B, Aji Vasahat, Rajkot-360 003.  
Call : +91 97277 33357, +91 97277 33358  
Email: loyalpump@gmail.com Visit us: www.loyalpump.com

સરદાર પતરા

Vardhman Industrial Zone, Plot No-15, S.V. No.-259 B/h-Kothariya Solvet,  
Kothariya, Rajkot - 360002. Gujarat (India), Call : +91 87994 54774







**RK**<sup>®</sup>  
AUTO SPARES



**SHALIMAR**  
Engineering Works

**Manu. : All Type of Engine Auto Valve**

6, Atika Ind. Area, Dhebar Road (South),  
Nr. Khodiyar Garage, Rajkot-360002  
Mobile : 9879991005  
Email : shalimaraautospare@gmail.com

**Arun**<sup>®</sup>  
PUMP

**Smart and Reliable  
Solar-Powered  
Pumping Solutions**

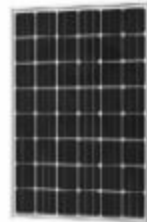

**AMAL PUMP LLP**  
Mfg. Submersible Pump & Openwell  
Pumps, Solar Pumps, Water Treatment  
Systems, etc.

**Hardik Patel**  
**+91 74055 73555**

**info@amalpump.com**  
**www.amalpump.com**

**Jay Chirag**<sup>®</sup>  
SUBMERSIBLE PUMP SET

MADE IN INDIA

V-3, V-4, V-5, V6,  
Submersible &  
Openwell Pump Set



Mfg. By:

**Chirag**  
Industries

Jay Sagar Industrial Estate, Rajkot - 360002 (Gujrat) India  
Tel: +91 281 2304039  
Email: info@chiragpumps.com  
www.chiragpumps.com



**GREENSTONE**<sup>®</sup>

**A Next Generation Product  
Green Building Solution**

Fly-Ash Bricks  
Plant



**Low Investment  
Quick Returns**

Light Weight Blocks Made Easy  
**CLC Plant**



Paver Block Plant  
CLC Block Plant  
Precast wall Plant  
Precast Mold  
Pre-Mix mortar plant  
All kind of Mixer

**HEM CARE CORPORATION**

Manufacturers & Exporters all kind of Eng. Goods.

Off. /Fac.: G/1505, G.I.D.C., Opp. Telephone Exchange, At. Metoda, Ta. Lodhika, Rajkot (Guj.) INDIA  
Phone: +91 94269 96888, 094262 01058 E-mail: hemcare@gmail.com

[www.hemcarecorporation.com](http://www.hemcarecorporation.com)

સરદાર પતરા

Vardhman Industrial Zone, Plot No-15, S.V. No.-259 B/h-Kothariya Solvet,  
Kothariya, Rajkot - 360002. Gujarat (India), Call : +91 87994 54774





## રાજકોટ એન્જીનીયરીંગ એસોસીએશન ઓડીટોરીયમ હોલ વપરાશ ચાર્જ્સ બેઠક વ્યવસ્થા ૩૩૦ વ્યક્તિ

ક્રમ	વિગત	૩ કલાક માટે (સ્તેબ-૧)	૬ કલાક માટે (સ્તેબ-૨)	૯ કલાક માટે (સ્તેબ-૩)
૧.	ઓડીટોરીયમ હોલ ભાડુ	રૂ. ૭,૦૦૦/-	રૂ. ૧૧,૦૦૦/-	રૂ. ૧૩,૫૦૦/-
૨.	સફાઈ તથા મેઈન્ટેનન્સ	રૂ. ૧,૩૦૦/-	રૂ. ૧,૩૦૦/-	રૂ. ૧,૩૦૦/-
૩.	માઈક ઓપરેટીંગ ચાર્જ	રૂ. ૨૨૫/-	રૂ. ૩૫૦/-	રૂ. ૪૦૦/-
૪.	કોર્ડ લેસ માઈક વપરાશ ચાર્જ	રૂ. ૧૦૦/-	રૂ. ૧૫૦/-	રૂ. ૨૦૦/-
૫.	કોલર માઈક વપરાશ ચાર્જ	રૂ. ૧૦૦/-	રૂ. ૧૫૦/-	રૂ. ૨૦૦/-
૬.	LCD પ્રોજેક્ટર/સ્ક્રીન 7x6	રૂ. ૧,૦૦૦/-	રૂ. ૧,૫૦૦/-	રૂ. ૨,૦૦૦/-
	LCD TV	રૂ. ૨,૦૦૦/-	રૂ. ૩,૦૦૦/-	રૂ. ૫,૦૦૦/-
૭.	જનરેટર ચાર્જ પ્રતિ કલાક	રૂ. ૩,૦૦૦/-	રૂ. ૩,૦૦૦/-	રૂ. ૩,૦૦૦/-
૮.	ઈલેક્ટ્રીક વપરાશ ચાર્જ પ્રતિ યુનિટ	રૂ. ૧૮.૦૦/-	રૂ. ૧૮.૦૦/-	રૂ. ૧૮.૦૦/-
૯.	GST	રૂ. ૧૮.૦૦%	રૂ. ૧૮.૦૦%	રૂ. ૧૮.૦૦%
૧૦.	બુકીંગ સમયે ડીપોઝીટ	રૂ. ૨૦,૦૦૦/-	રૂ. ૨૫,૦૦૦/-	રૂ. ૩૦,૦૦૦/-

## રાજકોટ એન્જીનીયરીંગ એસોસીએશન બોર્ડરૂમ/કોન્ફરન્સરૂમ વપરાશ ચાર્જ્સ બેઠક વ્યવસ્થા ૫૦ વ્યક્તિ

ક્રમ	વિગત	૩ કલાક માટે (સ્તેબ-૧)	૬ કલાક માટે (સ્તેબ-૨)	૯ કલાક માટે (સ્તેબ-૩)
૧.	બોર્ડરૂમ ભાડુ /કોન્ફરન્સ રૂમ	રૂ. ૩,૦૦૦/-	રૂ. ૪,૨૦૦/-	રૂ. ૫,૨૦૦/-
૨.	સફાઈ તથા મેઈન્ટેનન્સ	રૂ. ૨૭૫/-	રૂ. ૪૦૦/-	રૂ. ૪૦૦/-
૩.	માઈક ઓપરેટીંગ ચાર્જ	રૂ. ૧૨૫/-	રૂ. ૧૭૫/-	રૂ. ૨૨૫/-
૪.	કોર્ડ લેસ માઈક વપરાશ ચાર્જ	રૂ. ૧૦૦/-	રૂ. ૧૫૦/-	રૂ. ૨૦૦/-
૫.	કોલર માઈક વપરાશ ચાર્જ	રૂ. ૧૦૦/-	રૂ. ૧૫૦/-	રૂ. ૨૦૦/-
૬.	LCD પ્રોજેક્ટર	રૂ. ૧,૦૦૦/-	રૂ. ૧,૫૦૦/-	રૂ. ૨,૦૦૦/-
૭.	જનરેટર ચાર્જ પ્રતિ કલાક	રૂ. ૩,૦૦૦/-	રૂ. ૩,૦૦૦/-	રૂ. ૩,૦૦૦/-
૮.	ઈલેક્ટ્રીક વપરાશ ચાર્જ A.C.	રૂ. ૫૦૦/-	રૂ. ૭૦૦/-	રૂ. ૧,૦૦૦/-
૯.	GST	રૂ. ૧૮.૦૦%	રૂ. ૧૮.૦૦%	રૂ. ૧૮.૦૦%
૧૦.	બુકીંગ સમયે ડીપોઝીટ	રૂ. ૮,૦૦૦/-	રૂ. ૧૦,૦૦૦/-	રૂ. ૧૩,૦૦૦/-

wef. 01-05-2023

**નોંધ :** (૧) ઓડીટોરીયમ હોલ/બોર્ડરૂમ/કોન્ફરન્સરૂમ જેટલા સમય માટે **બુકીંગ કરાવેલ હોય તે સમય પહેલા અર્ધા કલાકે ખોલી**

**સોંપવામાં આવશે તેની ખાસ નોંધ લેવા વિનંતી.** તદ્દુપરાંત બુકીંગ કરાવેલ નિર્ધારિત સમયે તે પહેલાં, પાંચ મીનીટ અગાઉ કાર્યક્રમ પુરો કરી, ઓડીટોરીયમ હોલ/બોર્ડરૂમ/કોન્ફરન્સ રૂમ પરત સોંપવાનો રહેશે. જો આમ છતાં બુકીંગના નિર્ધારિત સમયથી કાર્યક્રમ વધુ ચાલશે તો તે પછીના સ્તેબનો ચાર્જ વસુલ કરવામાં આવશે.

(૨) **લંચની પરમીશન મળેલ હોય તો કેટરીંગ વિગેરેની વ્યવસ્થા આગલા દિવસે રાત્રે ૮.૦૦ વાગ્યા સુધીમાં કરવી અને ડીનર માટે બપોરે ૩.૩૦ વાગ્યા પછીથી વ્યવસ્થા કરવાની રહેશે** જેની ખાસ નોંધ લેવા વિનંતી.

(૩) પોર્ચ ઉપયોગનો ચાર્જ લંચ/ડીનર રૂ. ૧૫૦૦/-, હાઈ-ટી રૂ. ૧૦૦૦/- તેમજ ટી-કોફી ના રૂ. ૫૦૦/- અલગથી આપવાના રહેશે.

PAYMENT : RAJKOT ENGINEERING ASSOCIATION

BANK : BANK OF INDIA, SME BHAKTINAGAR BRANCH, RAJKOT.

A/C. No. : 312120110000222 IFC CODE : BKID0003121

સરદાર પત્ર

Vardhman Industrial Zone, Plot No-15, S.V. No.-259 B/h-Kothariya Solvet,  
Kothariya, Rajkot - 360002. Gujarat (India), Call : +91 87994 54774





## COMPLETE SOLUTION OF FOUNDRY EQUIPMENTS



**Muller Machine**  
Cap. 50kg., 1 Ton



**Gear Ladle**  
Cap. 250 kg to 5 Ton

**Intensive Sand Mixer**  
Cap. 100, 300, 500 Kg.



**Moulding Box**

Mfg. :  
All Type of  
Foundry  
Equipments



### PITHWA FOUNDRY EQUIPMENTS Co.

Sardar Industrial Area, Survey No. 261, Plot No. 51-52, Behind Kothariya Solvant, Gondal Road, RAJKOT. (Guj.) India. Phone : 0281 - 2391073  
**Mobile** : 98242 17299 # **E-mail** : new\_pithwa@yahoo.co.in # **Website** : www.newpithwa.com

*Pithwa*  
Electronic &  
Mechanical Safes



MITESH B. PITHWA ☎: 98244 87855

### NEW PITHWA FABRICATION

Office : 13/14, Vijay Plot Main Road, Opp. Globe Transport, Rajkot -2 (Guj.) India. #Ph.: +91-281-2462358 .



## KRISHNA CASTING



**Manu. ALL KIND OF C.I.  
GRADED CASTING**



**Address** : Jilla Garden Main Road, 4, Bapunagar,  
Rajkot - 36002, (Gujarat), India **Phone No** : 281 2232005  
**Email** : krishnacasting@yahoo.com, **Web.**: www.krishnacasting.com  
**Bhavesh Vaghasia Mo.** : 98795 99979

સરદાર પતરા

Vardhman Industrial Zone, Plot No-15, S.V. No.-259 B/h-Kothariya Solvet,  
Kothariya, Rajkot - 360002. Gujarat (India), Call : +91 87994 54774



# ZMZO<sup>®</sup>



**SINCE 1986**

Sand Molding Machine  
Gravity Casting Machine  
Core Shooting Machine  
Casting Mold  
Casting

**OM ENGINEERING SOLUTION**

Address: Om Engineering Solution Bhavnagar Road, Aji Vashat Rajkot - 360001

Mo. No. : Darshit Patel - +91 9824209496, China : +86 133 3672 1900

Email : info@pecl.co / ora@zmzogroup.com, Web. : www.zmzogroup.com

સરદાર પત્ર

Vardhman Industrial Zone, Plot No-15, S.V. No.-259 B/h-Kothariya Solvet,  
Kothariya, Rajkot - 360002. Gujarat (India), Call : +91 87994 54774

SARDAR  
Engineering Solutions





Cast iron rotors



Cast iron rotors and drums



Cast iron engine



Cast iron drums



Ductile iron pipes



Cast iron 5-25 kgs



Cast iron 25-70 kgs



Cast iron broken Machinery



Cast iron chips



M S profile cutting scrap



M S plate cutting scrap



M S fish cutting scrap



M S angle cutting scrap



Busheling scrap



CRC busheling bales



Seamless & welded pipes



Alloy Steel Scrap



Secondary M S plates



## FINE TRADE LINK

CAST IRON SCRAP | MS SCRAP | MS PIPES | PROFILE PLATES | PRIME PLATES

📍 10th Floor, Office No.10, Victoria Bliss, Opp. Victoria Park, Iscon Mega City, Bhavnagar-364001 (Gujarat) India

☎ +91-8141 464 646 / +91-9979 140 000 📞 +91-278-2421414 / 2421412

✉ info@finetradelink.com 📧 finetradelink@yahoo.com 🌐 www.finetradelink.com

સરદાર પતરા

Vardhman Industrial Zone, Plot No-15, S.V. No.-259 B/h-Kothariya Solvet, Kothariya, Rajkot - 360002. Gujarat (India), Call : +91 87994 54774







# RAJKOT ENGINEERING ASSOCIATION

## REANA સભ્યોની સવલત અંગેની ઉપલબ્ધિતાઓ

૧. એક્સપોર્ટર માટે સર્ટીફિકેટ ઓફ ઓરીજન ચાર્જ રૂ. ૧૩૦/- પ્રતિ સર્ટીફિકેટની સવલત.
૨. ઓડિટરીયમની સવલતો
  - A.C. કોન્ફરન્સ રૂમ ૫૦ ની બેઠક સાથે.
  - A.C. બોર્ડ રૂમ ૫૦ ની બેઠક સાથે.
  - A.C. ઓડિટરીયમ ૩૩૦ ની બેઠક સાથે.
  - LED TV / અલ્ટ્રા મોર્ડન સાઉન્ડ સીસ્ટમ, મોટોરાઈઝ્ડ સ્ક્રીન, પ્રોજેક્ટર તથા લેપટોપ સાથેની સવલત.
૩. વિડીયો કોન્ફરન્સીંગ ફેસેલીટી જેમાં ૨૫ સીટીંગ કેપેસિટીની સવલત.
૪. લાયબ્રેરી : ટેકનિકલ, નોન ટેકનિકલ બુક્સ સાથેની અદ્યતન સુવિધા સાથેની લાયબ્રેરી.

ભક્તિનગર ઇન્ડ. એસ્ટેટ જી.આ.ડી.સી.,

શેરી નં.-૩, રાજકોટ.

Mo. 99132 14935 / Email : info@reaindia.com



સરદાર પત્ર

Vardhman Industrial Zone, Plot No-15, S.V. No.-259 B/h-Kothariya Solvet,  
Kothariya, Rajkot - 360002. Gujarat (India), Call : +91 87994 54774

SARDAR  
INDUSTRIAL ZONE





Manufactures :  
 CNC, PLC Hydraulic, Internal, External & SPM  
**Grinding Machine,**  
 For Production & Tool Room



CNC Cylindrical Grinding Machine  
2000 mm



Cylindrical Grinding Machine  
150 x 300 mm

**श्री BUTHAVANI**  
**MECHANIC WORKS**

J.P. Marg, Street No. 1 Dudhrej Road, Surendranagar - 363 001. Gujarat, India.  
 Mobile : 09925004333, 09825223885 | Email : [bmwswasticgrinders@gmail.com](mailto:bmwswasticgrinders@gmail.com)

[www.swasticgrinders.com](http://www.swasticgrinders.com)



An ISO 9001:2015 Company

Active in  
Pumping Water



- 40 | Feet Head Per Stage in V-5 Pump
- 45 | Feet Head Per Stage in V-6 Pump
- 50 | Feet Head Per Stage in V-6 Pump
- 70 | Feet Head Per Stage in V-6 Pump
- CED | Coating On All Casting Parts

Mfg.: V-3, V-4, V-5, V-6 & Openwell  
 Submersible Pumps

Manufactured By:  
**ACTIVA PUMPS**

Somnath Ind. Area, In Side Kothariya Railway Crossing, Opp. Krishana Park  
 Hotel, Gondal Highway, Rajkot. (Guj.) Mo. +91 98257 23323  
 ✉ [activapumps@gmail.com](mailto:activapumps@gmail.com) 🌐 [www.activapumps.in](http://www.activapumps.in)

સરદાર પતરા

Vardhman Industrial Zone, Plot No-15, S.V. No.-259 B/h-Kothariya Solvet,  
 Kothariya, Rajkot - 360002. Gujarat (India), Call : +91 87994 54774





SINCE 1963

Fieldmarshal

Marshalling Green Fields

MILLIONS OF SATISFIED CUSTOMERS WORLDWIDE



FMA 12 and FMW 14 Engines

PMT 15 and PMT 18 Engines

Bore well Submersible Pumps

CPVC, UPVC, SWR and AGR1 Pipes & Fittings

Lister Engines

High Speed Diesel Engines and Pump Sets

Mini Manablock Pumps

55 Open well Submersible Pumps

Induction Motor

Centrifugal Manablock Pumps

Alternators

C Body Open Well Submersible Pumps

Mini Manablock Pumps



P. M. DIESELS PVT. LTD. , ARVIND INDUSTRIES P.O. BOX NO. 1003, AJI INDUSTRIAL ESTATE, RAJKOT - 360003 (GUJRAT - INDIA) Phone: +91-9106882861 Fax: +91-9023550564 Email: contactus@fieldmarshal.com



સરદાર પત્ર

Vardhman Industrial Zone, Plot No-15, S.V. No.-259 B/h-Kothariya Solvet, Kothariya, Rajkot - 360002. Gujarat (India), Call : +91 87994 54774





# Discover THE WORLD WITH US



## Unlock Exclusive Our Services

- ✦ FLIGHT BOOKING
- ✦ CRUISE BOOKING
- ✦ HOTEL BOOKING
- ✦ DOMESTIC & INTERNATIONAL TOUR PACKAGES
- ✦ MICE & CORPORATE TOURS
- ✦ CHARTER FLIGHT BOOKING
- ✦ EURO RAIL BOOKING
- ✦ PASSPORT ASSISTANCE
- ✦ USA & CANADA PASSPORT RENEWAL
- ✦ VISA SERVICE
- ✦ CANADA PR PROCESS
- ✦ ATTESTATION / APOSTILLE SERVICE
- ✦ TRANSLATION SERVICE



ASSOCIATE WITH



102 - Balaji Square, Sarveshwar Chowk,  
Yagnik Road, Rajkot - 360001

099240 77731 / 099248 77731

www.royaltourstravels.com  
royaltourstravels@gmail.com



Our Machines, Ranging From 40KW To 100KW, Are Engineered To Meet The Demands Of Modern Industry, Offering Unmatched Precision, Reliability, And Efficiency

## SPECIAL APPLICATION OF OUR PRODUCT



STRIP HEATING



INDUCTION BRAZING



SHRINK FITTING



INDUCTION HEATING



INDUCTION ANNEALING

### OUR PRESENT IN ABROAD

- UAE (Dubai)
- USA
- MALAYSIA
- SINGAPORE
- AUSTRALIA
- BANGLADESH
- ITALY
- NEPAL
- OMAN
- SAUDI ARABIA
- TANZANIA
- SRI LANKA



WWW.SHAPET.IN

### SHAPET INDUCTION PVT. LTD.

Gate No. 1, Plot No.-2605/A, Rd Number 11, GIDC Metoda,  
Near Silver Techno cast, Metoda-360021. Gujarat (India)

+91 98794 61162 / +91 98253 69897

Sale@shapet.com

સરદાર પતરા

Vardhman Industrial Zone, Plot No-15, S.V. No.-259 B/h-Kothariya Solvet,  
Kothariya, Rajkot - 360002. Gujarat (India), Call : +91 87994 54774



## REVOLUTIONIZING GRINDING SOLUTIONS

# KIYA



**EG Series**  
CNC External Cylindrical Grinders

**HCG Series**  
Hydraulic Cylindrical Grinders

**CL 100**  
Hydraulic Centerless Grinder

**IG 30**  
CNC Internal Cylindrical Grinder

### GRINDING SOLUTIONS

- CNC External Cylindrical & Track Grinder
- CNC Internal Cylindrical & Track Grinder
- CNC Centerless Plunge Grinder
- CNC LIP Grinder
- Horizontal Spindle Rotary Table Surface Grinder
- External Cylindrical Grinder
- Internal Cylindrical Grinder
- Centerless Grinder
- Special Purpose Grinder

## ABOUT US

KIYA PRODUCTS PRIVATE LIMITED is a rajkot based manufacturer of precision grinding machines under the brand name "KIYA" with a legacy of more than 3 decades of its heritage. To accommodate our growing business "Ignite Inc" formerly known as Champkraft Machine Tools under the brand name "Solco Grinders" with a legacy of over 35+ years in grinding machines is now moved to Rajkot with a better infrastructure, quality, and a new range of grinding machines. Kiya portrays its extensive expertise in manufacturing various grinding machines meeting the customer's prospects and expectations in terms of quality, precision, productivity & reliability.

# KIYA

#### Kiya Products Private Limited

Plot No. G-1925, Gate-2 (Almighty Gate), Kalawad Road,  
Lodhika GIDC, Vill- Metoda, Dist- Rajkot 360 021, Gujarat, India.  
E info@kiyaproducts.com M +91 99789 61509

Sales | sales@kiyaproducts.com, +91 93281 61506,  
Service | service@kiyaproducts.com, +91 99781 61507

kiyaproducts.com

સરદાર પત્ર

Vardhman Industrial Zone, Plot No-15, S.V. No.-259 B/h-Kothariya Solvet,  
Kothariya, Rajkot - 360002. Gujarat (India), Call : +91 87994 54774

SARDAR  
KOTHIYAS



Fly Your Dreams...  
**BEST**<sup>®</sup>  
 TOURS & FOREX Pvt. Ltd.  
 SINCE: 1996

# ગુજરાતી મહારાજ સાથે યુરોપ તથા અન્ય દેશોના ગ્રુપ પ્રવાસો 2025ની સ્કીમનો લાભ લેવા સંપર્ક કરો



EUROPE

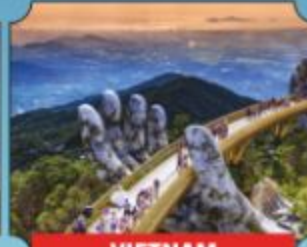

VIETNAM



TURKEY



SCANDINAVIA



SOUTH AFRICA



SPAIN &amp; PORTUGAL



CANADA WITH CRUISE

📍 RAJKOT  
 ☎ +91 80005 00050  
 📍 AHMEDABAD  
 ☎ +91 81005 00050



સરઘર પત્ર

Vardhman Industrial Zone, Plot No-15, S.V. No.-259 B/h-Kothariya Solvet,  
 Kothariya, Rajkot - 360002. Gujarat (India), Call : +91 87994 54774

SARDAR  
 TRAVEL & TOURS

Sagar Parsana  
+91 98795 86565

Bansi Parsana  
+91 96876 10910



**Mfgr. of all kinds of Precision Graded  
C.I. Casting. Ranges from 1 kg. to 15 Ton**

📍 2-Sanskar Society, Near Khokhad Dadi River,  
National Highway-27, Rajkot - 360 002.

✉ info.krunalmanu@gmail.com

સરદાર પતરા

Vardhman Industrial Zone, Plot No-15, S.V. No.-259 B/h-Kothariya Solvet,  
Kothariya, Rajkot - 360002. Gujarat (India), Call : +91 87994 54774





**Shailesh**  
SINCE 1970

**TWO COLUMN WIDE BED PRESS**

HYDRAULIC SHEARING MACHINE    HYDRAULIC PRESSBRAKE MACHINE    TYPE DIE CAST PRESS MACHINE    TYPE FORGE PRESS MACHINE

MANUFACTURED & EXPORTED BY  
**SHAILESH GROUP OF COMPANIES**

2/10 (NEW 20), Shaktinagar Station Plot Rajkot - 360 002, Gujarat - India  
Email - info@shaileshmachines.com | 3602 - www.shaileshmachines.com & www.lokniprivesh.com

**DIPESH**  
Since 1979

**MANUFACTURE OF HYDRAULIC THREAD ROLLING MACHINE.**

**Golden Client**

Hydraulic Thread Rolling Machine Model D1 20mm    Hydraulic Thread Rolling Machine Model D1 40mm

Plot No. G-2052/A, Near Shree Ram Hospital, Kishan Gate, Kalawad Road, Metoda GIDC, Rajkot (Gujarat - India).  
Ph. 02827 - 288032, Mo. 90799 90032 / 90138 55204 / 73631 02032  
E-mail: info@dipeshindustries.in | dipeshmakwana5@gmail.com  
Web: www.dipeshindustries.in

**SCM SHREE CHAMUNDA METALS**

**Our Expertise**

Tractor Sheet Metal Parts.  
Rotavator Sheet Metal Parts.  
All Type Of Sheet Metal Works.  
Deep Draw Works.

**SHREE CHAMUNDA METALS**

Address : 149/A Meera Udhayog, Street no. 8, Nr. Banshidhar Weigh Bridge, Aji Vasahat, Rajkot - 360003.  
Call : 90333 38040 | 90993 78497

**ONE STOP SHOWROOM FOR HOSPITAL & HEALTHCARE PRODUCTS.**

AN ISO 9001 : 2008 & ISO 13485 : 2015 AC 2012, CE, FDA & GMP CERTIFIED COMPANY

**WESTERN SURGICAL EQUIPMENTS PRIVATE LIMITED**

We are Available on :

**OUR CORPORATE OFFICE**

"Happy Home", 1st Floor, 23, Kankipara, B/R, S.T Bus Stand, Kanak Road, Rajkot-360 001. Ph. : +91 201-2232871/2243159  
Mo. : +91 98250 89009 - +91 98250 45997  
Email : westernsurgical@gmail.com  
www.westernsurgical.in

**OUR MANUFACTURING UNIT**

7-Dhwan Industrial Estate, Nr. Kothariya Railway Crossing, B/h. Jay Ganesh Ford Service Center, NH-48, Gondal Road, Nr. Neera Papari, Rajkot-360 007, Gujarat (India).  
M. : +91-94289 03751





## DRILLS, ENDMILLS, REAMERS, THREADMILLS & CUSTOMIZED TOOLS

Manufacturing & Re Conditioning  
of Solid Carbide Round Tools

OPPORTUNITY FOR SOLID CARBIDE TOOLS!



### MANUFACTURER OF SOLID CARBIDE TOOLS

59 - A, Maruti Industrial Estate, B/h. Ashish Engineering Works, Outside,  
Octroi Post, Gondal Road, Rajkot - 360004, Gujarat (INDIA).

info@smoothtools.in | www.smoothtools.in | +91 99131 01111, +91 99786 99789

Follow Us On :



**Nailless Plywood Box**  
**Plywood Pallet**  
**Pinewood Pallet**  
**Pinewood Box**

**Nailless Box** are  
*Manufactured with*  
**German Technology.**

#### JAGTAT WOOD PACKSAFE

Plot No.-1 & 2/3, Survey No. 289,  
Vill. New Haripar (Taravada), Tal. Lodhika,  
Dist. Rajkot - 360 004. Gujarat, India.  
+91-99250 19190 | +91-94088 61715  
jagtat.wps@gmail.com | www.jagtatnaillessbox.com



**JAGTAT**  
*we protect your product*



સરદાર પતરા

Vardhman Industrial Zone, Plot No-15, S.V. No.-259 B/h-Kothariya Solvet,  
Kothariya, Rajkot - 360002. Gujarat (India), Call : +91 87994 54774





# Jagdish®

Submersible Pumps

Since 1985



**JAGDISH ENGINEERING INDUSTRIES**

RAJKOT (GUJARAT)

MOBILE : 70418 87873 / 70418 87879

# Addison®

The Safe Connection  
ELECTRIC WIRES & CABLES



**PRODUCT RANGE :-**

- FR & FR-LSH House Wires
- Submersible Flat Cables
- Industrial Cables
- Multi core Flexible Cables
- Aluminium Cables
- LT Power And Control Cables



AN ISO 9001 : 2015 Company



Mfg. By: **ADDISON CABLE PVT. LTD.**

Plot No. 7 - 8/9, Road No. 8, Opp. V-Trans, Kalyand Road, G.I.D.C. Ladhka, AT - METODA - 360 021, Dist. Rajkot (Guj.) INDIA.  
Ph. :- +91-2827-287475/297475 Mo. :- +91 98252 81182  
E: info@addisoncables.com W: www.addisoncables.com

Mfg. By: **ADDISON INDUSTRIES**

B/H. Wadkar Enterprise, Aika Street No. 11, Dhebar Road(South), Rajkot - 360002  
Mo. :- +91 99135 15253  
Ph. :- +91 281 238537 / 2381598



**MINIMATIC®**  
MOST TRUSTED NAME IN SPM

## CNC Turning Center



**Sliding Head CNC**  
(SLD-10 & SLD-20)



**CNC Turning Center**  
(MGT-75)



**MINIMATIC MACHINES**

Plot No. G-3077, Road L-1, GIDC Ladhka, Almighty Gate, V.H. Metoda, Dist. Rajkot - 360021.  
Mob. 9527211134 | Email : sales@minimaticmachines.com  
URL : www.minimaticmachines.com | www.indiamart.com/minimatic-machines

## SUPER SLIDE

**BALL SCREW, LM GUIDEWAYS & CNC ACCESSORIES**



**PMI BALLSCREWS**



**PMI LINEAR GUIDEWAYS**



**YINSH PRECISION LOCK NUTS**



Flexible couplings for Servo Motors



Ballscrew Support Units

## MACHINING SYSTEMS

Veer Narmad Township Shop No.-4, Samrat Indl. Area Main Road, B/H S.T. Workshop, Gondal Road, Rajkot - 360 004. (Guj.)

Contact No. : 097123 59021

E-mail : ballscrew.rajkot@gmail.com

**www.superslides.in**

સરદાર પતરા

Vardhman Industrial Zone, Plot No-15, S.V. No.-259 B/h-Kothariya Solvet, Kothariya, Rajkot - 360002. Gujarat (India), Call : +91 87994 54774





# AirTract

## Total Solution for Air & Pneumatic Equipment



AN ISO 9001:2015 COMPANY



MFG. BY:

**RAJAN MACHINES (INDIA) PVT. LTD.**

AKAR ESTATE, 1<sup>ST</sup> FLOOR, 3-ATIKA INDUSTRIAL AREA, DHEBAR ROAD (SOUTH), RAJKOT 360 002. (INDIA)

+91 96019 38051, 9081839200, 9081839300

rajanmachinesindia@gmail.com www.rajdhaniaircompressor.com



# AMEER

# अमीर



An ISO 9001:2015 Company

# Century

# सेंट्युरी



WIDE RANGE IN COOLANT PUMP

## CENTURY AGRO ENGINEERS

2-Umakant Udhyognagar, Mavdi Plot, RAJKOT - 360 004.

Cell No.: 78020 06464 E-mail : ameerrajkot@yahoo.com, Visit us: www.ameerrajkot.com

સરદાર પત્રા

Vardhman Industrial Zone, Plot No-15, S.V. No.-259 B/h-Kothariya Solvet, Kothariya, Rajkot - 360002. Gujarat (India), Call : +91 87994 54774





# Manufacturer of EOT Crane & Material Handling Equipments

# TOP CRANE®

Maximizing The Human Efficiency



DOUBLE GIRDER EOT CRANE



GOLIATH CRANE



SINGLE GIRDER EOT



JIB CRANE



WIRE ROPE CRAB



WIRE ROPE HOIST



END CARRIAGE



MATERIAL HANDLING SOLUTION

## TOP CRANE SYSTEM PVT.LTD.

Maximizing The Human Efficiency

Email : [sales@topcrane.in](mailto:sales@topcrane.in) / [inquiry@topcrane.in](mailto:inquiry@topcrane.in)

Website : [www.topcrane.in](http://www.topcrane.in)

Mo. : +91 6354 011 480 | +91 97129 77753

Mfg. : All Kinds Of Gunmetal & Phosphorus Bronze Metal Bushes, Split Brass, Gears And Non Ferrous Casting From 10gms To 250kgs As A Single PC Of Precision Components.



ISO 9001 : 2015

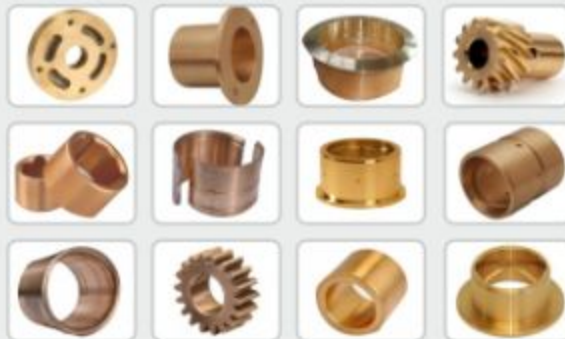

## SAURASHTRA BRASS INDUSTRIES LLP

"METAL HOUSE", NR. ANDH MAHILA VIKAS GRUH, DHEBAR ROAD, RAJKOT - 360 002 (GUJARAT). INDIA

EMAIL : [saurashtrabrass@gmail.com](mailto:saurashtrabrass@gmail.com), [info@saurashtrabrass.com](mailto:info@saurashtrabrass.com)

WEB : [www.saurashtrabrass.com](http://www.saurashtrabrass.com)

Mob. : +91 97277 55993, +91 99250 01445

MR. DARSHIT PATEL, MR. PRATIK PATEL

સરદાર પતરા

Vardhman Industrial Zone, Plot No-15, S.V. No.-259 B/h-Kothariya Solvet, Kothariya, Rajkot - 360002. Gujarat (India), Call : +91 87994 54774





**MANUFACTURER AND EXPORTER  
OF HYDRAULIC & OTHER TRACTOR PARTS**  
Driving Innovation. Powering Agriculture  
Your Trusted Source for Quality Tractor Parts!



**KALAPI TRACTOR SPARES PVT.LTD.**



**Fashion redefined, for men of distinction.**  
Impeccable craftsmanship weaves Italian grace.  
A versatile range of pure wool fabrics handpicked  
from the heart of Italy where fashion meets  
everlasting elegance.



**REGIO ITALIA**  
PURE WOOL FABRICS

Available at



RAJKOT  
Scan For Location



MORBI  
Scan For Location

RAJKOT: Nakshatra-2, 150 Ft. Ring Road, Nr. KKV Circle ☎910652077  
MORBI: Ram Chowk, Savsar Plot Main Road ☎7016086599

## ATUL MACHINE TOOLS

Quality is a Matter of Trust



CNC External Grinding Machine  
Size : 600 mm & 1000 mm



Hydraulic & Mechanical Cylindrical Grinding Machine  
Size : 450 mm to 1500 mm



Hydraulic & Manual  
Surface Grinding Machine  
Size : 600 x 300 mm, 400 x 220 mm

Website : [www.atulmachine.com](http://www.atulmachine.com)

Almighty Gate, Plot No. P-103, Lodhika G.I.D.C, Kalawad Road, Metoda, Rajkot, Gujarat-360021, India.  
Office : +91-2827-297607 | Mob. : +91-8758466424 | Email : [sales.atulmachinetools@gmail.com](mailto:sales.atulmachinetools@gmail.com)

**Manufacturer &  
Importer of :**  
All Kind of  
Fasteners

माँ



# S. N. Enterprise

"Shree Shakti", Godown Road, 14-Bhaktinagar Station Plot,  
Nr. Pashu Dawakhana, Rajkot - 360 002.

☎ 90161 03404 ☎ 97266 03404

✉ [nemish@sngroups.in](mailto:nemish@sngroups.in) 🌐 [www.sngroups.in](http://www.sngroups.in)

સરદાર પત્રા

Vardhman Industrial Zone, Plot No-15, S.V. No.-259 B/h-Kothariya Solvet,  
Kothariya, Rajkot - 360002. Gujarat (India), Call : +91 87994 54774





**VIKRAM**
[www.vikramvalves.com](http://www.vikramvalves.com)

 IATF 16949:2016, ISO 14001:2015, ISO 45001:2018  
 Certified Company

## A Global Supplier of Engine Valves

**Serving a Diverse, Global Customer Base for more than 45 years**

AVR (Vikram) Valves is one the most reliable and trusted source for **High Quality Engine Valves & Valve Train Components** for a wide array of Industries, including Tier-1 and Tier-2 Automotive Manufacturers. 'Vikram' is now a Globally recognized Brand and Company is matching the footsteps of Globalization by exporting to **USA, UK, Germany, China, South Korea** and almost all over the World.



### AVR (Vikram) Valves Pvt. Ltd.

Plot No. 2317-2318, G.I.D.C Lodhika Industrial Estate, Almighty Gate No. 2, Rajkot - 360 021, (Gujarat) India.  
 T: +91 2827 287358 | 287359 E: [info@vikramvalves.com](mailto:info@vikramvalves.com) W: [www.vikramvalves.com](http://www.vikramvalves.com)

**સરદાર પતરા**

Vardhman Industrial Zone, Plot No-15, S.V. No.-259 B/h-Kothariya Solvet,  
 Kothariya, Rajkot - 360002. Gujarat (India), Call : +91 87994 54774

**SARDAR**  
 Engineering & Services

# Kiran INDUSTRIES

# K+



## ANCHORING YOUR SUCCESS EVERY STEP OF THE WAY



**ALLEN CAP BOLTS**  
**HIGH TENSILE HEX BOLTS**  
**HIGH TENSILE HEX NUT**

**HEX BOLTS & HEX NUT**  
**FLANGE NUT**  
**HEX WELD NUT**

**COPPER BOLT & NUT**  
**BRASS BOLT & NUT**  
**CUSTOM FASTENERS**



**RAJ BHALANI**  
+91 98245-98000

**KETAN BHALANI**  
+91 99045-98000

kiran.fastners@yahoo.com  
Sr. No. 211, Plot No. 3, Essan Road,  
Al Veraval- Shapar, Tal. Kolda Sangani,  
Dist. Rajkot - 360 024. (Gujarat) INDIA.

સરદાર પત્ર

Vardhman Industrial Zone, Plot No-15, S.V. No.-259 B/h-Kothariya Solvet,  
Kothariya, Rajkot - 360002. Gujarat (India), Call : +91 87994 54774





**MANUFACTURER OF ALL TYPE OF ENGINE VALVE**



G-409/410, Opp. Decora Bhavan, G.I.D.C. Metoda, Kalawad Road,  
 Rajkot - 360021 (INDIA) | Telefax : +91-2827-287285, 287385  
 Email : unicornvalves@yahoo.co.in | Website : www.unicornvalves.com



Mfg. : Mild Steel, Stainless Steel, Manganese Steel,  
 Marine Anchor & Alloy Castings  
 Capacity : Single Pic - 5 Kg to 4000 Kg.



**Poonam Metals**

Metoda GIDC, Plot No. G-1330, Opp. Kishan Auto, Kishan Gate, Klawad Road,  
 Dist. Rajkot - 360021, Gujarat (INDIA) Mo. : +91 99981 13603, +91 97149 99905  
 E-mail : poonammetals1330@gmail.com Web. : www.poonammetals.co.in



સરદાર પત્ર

Vardhman Industrial Zone, Plot No-15, S.V. No.-259 B/h-Kothariya Solvet,  
 Kothariya, Rajkot - 360002. Gujarat (India), Call : +91 87994 54774





# OM METALCAST

SHAPING THE FUTURE

AN ISO 9001:2015 CERTIFIED COMPANY



Manufactures of Grey & SG Iron Castings.

Product Range:

- ELECTRIC MOTOR STATOR HOUSING & PARTS
- MOTOR STATOR & SHIELD COVERS
- SUBMERSIBLE PUMP CASTING PARTS
- BEARING COVERS & BEARING HOUSING
- OTHER GRADED GREY & SG IRON CASTING

Office & Work :

Survey No. 280/1, Opp. Prince Villa, Kuvadva-Wankaner Road,  
NH-27, Village : Jhiyana. POST: Jhiyana. Dist. Rajkot - 360023. (Gujarat)  
info@ommetailcast.com www.ommetailcast.com

Sunilbhai Patel  
+91 94262 16320

Milan Patel  
+91 92277 60040

# Sterling®

SUBMERSIBLE PUMPS

CELEBRATING  
**25 YEARS**  
OF EXCELLENCE  
1997-2022



A Wide Range of Quality Pump Sets

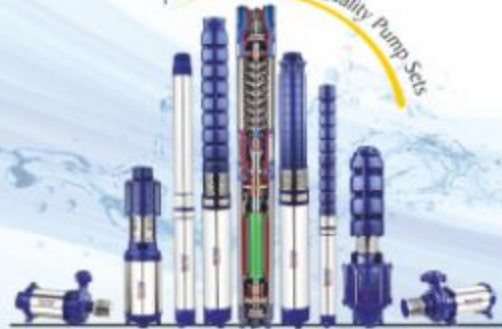

The Most Rugged, Trouble Free & Economical Pump Set.



## SIDDHI ENGINEERS

Mfg. : SUBMERSIBLE PUMPSETS

G-2223, Kranti Gate Main Road, Lodhika G.I.D.C., Al. METODA, Dist. Rajkot - 360 021 (Gujarat) INDIA.  
Phone : +91 2827 287168 • Mo. : +91 70465 00065 • E-mail: info@sterlingpumps.in • Web: www.sterlingpumps.in

Mfg. of : 0.5 HP to 10 HP SINGLE & THREE  
PHASE INDUCTION MOTOR



Mfg. of : ALL SUBMERSIBLE CASTING KIT



## BEM Jay Bajarang Electric Manufacture

Laxminnagar Main Road, 6-Mahadev Wadi,  
B/h. Haveli, Mavdi Plot, Rajkot - 360 004  
E-mail : jaybajrangeleandmanufacture@gmail.com  
Ph. : 0281-2371667, Cell : +91 98256 72592



ALL KINDS OF C.I. CASTING MANUFACTURERS



## Murlidhar® TECHNOCAST

Gondal Road High-way,  
B/h. Parin Furniture,  
Rani Industrial Area,  
Survey No. 17,  
Vavdi-Rajkot  
Vallabhbhai Patel  
98250 94924



Web : www.murlidhartechnocast.com • Email : murlidhartechnocast@gmail.com

સરદાર પત્રા

Vardhman Industrial Zone, Plot No-15, S.V. No.-259 B/h-Kothariya Solvet,  
Kothariya, Rajkot - 360002. Gujarat (India), Call : +91 87994 54774





**Rashmi Patel**B.E. (Mech), PGDFM  
Mo. : +91 98257 09220**Nishant Patel**B.E. (Mech), MBA  
Mo. : +91 94295 79366

Mfg. of Bearing Lock Nuts,  
Adapter Sleeves,  
Lock Washer, Precision Lock,  
Nuts and Hook Spanners

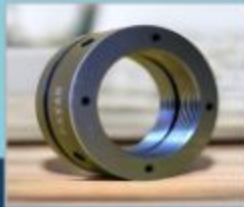

**pavan**  
ENTERPRISE

2, Gokulnagar, Nr. Nirav Commercial Complex,  
Gokuldham Main Road, Rajkot - 360 004  
Ph.: 0281 - 2312005,  
Email : rppatel.pavan@gmail.com

www.stampingsindia.com



**QUALITY**  
The Right  
Choice.

We are **Unique** in  
**Quality** Products...



**PRECISION**  
STAMPING INDUSTRIES

Call us now... **098250 76967**

Manu. : All kind of Electrical Stampings & Laminations

Plot No. G-1882-83, M-Road, Kishan Gate, ( Gate No. 3 )  
Nr. Shree Ram Hospital, Lodhika G.I.D.C., Dist Rajkot, At Metoda.

☎ : +91 - 2827 - 287513  
☎ : +91 98250 76967

✉ : info@stampingsindia.com  
🌐 : www.stampingsindia.com

સરદાર પતરા

Vardhman Industrial Zone, Plot No-15, S.V. No.-259 B/h-Kothariya Solvet,  
Kothariya, Rajkot - 360002. Gujarat (India), Call : +91 87994 54774

**SARDAR**  
INDUSTRIES



### Engines - Diesel



### Spare Part of Engine



### Pump & Mud Pump



### Oil / Pipe



Manufacturer & Exporter (An ISO 9001:2015 Certified Company)

**GUJARAT FORGINGS PVT. LTD.**

Opp. N.S.I.C., 80 Feet Road, Aji Industrial Area, Rajkot - 360 003 (India).

Email: [info@fieldmarshalengine.com](mailto:info@fieldmarshalengine.com) | Customer Care No. +91 99740 56831/32/34

Web: [www.speedwel.com](http://www.speedwel.com) | Follow us: @Speedwel | +91 99740 56831

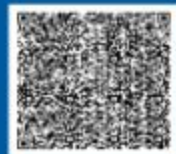

સરદાર પત્રા

Vardhman Industrial Zone, Plot No-15, S.V. No.-259 B/h-Kothariya Solvet,  
Kothariya, Rajkot - 360002. Gujarat (India), Call : +91 87994 54774





## Precision *Aluminium Castings for* Perfect Engineering



"Focussed on delivering estimates that align with your goals, budget and timeline perfectly."

- **Precision-Crafted Components**  
Manufactured to meet diverse industrial needs.
- **Custom Casting Solutions**  
Expertise in creating parts for automotive, hardware and more.
- **Wide Range of Applications**  
Engine parts, brackets, housings and more.
- **Trusted by Leading Brands**  
A proven track record across industries for quality.



### Contact Us:

+91 99252 31722 | info@tattvanalumicast.com | www.tattvanalumicast.com  
Copper Ind. Area, Shed No. 2 & 3, Opp. Kalpvan, At - Kangshiyall, Rajkot, Gujarat - 360022.



AN ISO 9001 : 2015  
Certified Company



Serving  
**Pump  
Valve  
Earthmoving  
Oil & Gas  
Industries**



  
**RANGE PRECISE**  
perfection in every micron

**Precision Machined Components  
& Sub Assemblies**  
Made From **Bar Stock & Forgings**

7, Mani Nagar, Mavdi Plot, Rajkot - Gujrat, India.  
Landline : +91 281-2377797 | Mo : +91 9725552211  
E-mail : sales@rangeprecise.com | Web : www.rangeprecise.com

સરદાર પતરા

Vardhman Industrial Zone, Plot No-15, S.V. No.-259 B/h-Kothariya Solvet,  
Kothariya, Rajkot - 360002. Gujarat (India), Call : +91 87994 54774





## The single window to every logistics solution you need

From transportation solutions for different kinds and sizes of cargo, to anywhere-in-India reach and warehousing services and more... V-Trans has it all and is therefore the partner of choice for countless businesses in diverse sectors.



DIFFERENT ARMS,  
MANY POSSIBILITIES:



Solutions: Surface transportation, Time-bound express cargo, Warehousing and inventory management, Integrated supply chain



V-Trans (India) Limited Head Office: Unit 06, Corporate Park, V N Purav Marg, Chembur, Mumbai - 400 071.  
 ☎ 9870140141 ✉ info@vtransgroup.com 🌐 www.vtransgroup.com  
 To know more, call us on 9376 888 837 | Email: jignesh@vtransgroup.com

We Believe in Quality

# TEZZ®

Air Compressor



Double &  
Single Cylinder  
Air Compressor



Manu. & Mrkt. : Air Compressor, Sprayer Pump, Cut off Machine,  
Electric Air Blower, Electric Motor & Jigsaw Machine.



**SHIV SHAKTI ENTERPRISE**

Survey No. 32, Plot No. 6, Opp. Poonam Dumper, Street of Perfect Tata Show Room,  
Rajkot Gondal Highway, Vard, Rajkot-360004 (Gujarat)  
No. : 9428996444, 9979277540, 9723871960 E-mail : info@tezzaircompressor.in

# Filltop®

SUBMERSIBLE PUMPS

एक कदम....  
समृद्धि की ओर....



Manu. By : **B.M. ENTERPRISE**

Ankit Industrial Estate, Plot No. 11, Opp. Krishna Park  
Railway Crossing, Gondal Road, (Kothariya) Rajkot. (Guj.) INDIA  
Customer Care No. : 88 66 74 20 62

સરદાર પતરા

Vardhman Industrial Zone, Plot No-15, S.V. No.-259 B/h-Kothariya Solvet,  
Kothariya, Rajkot - 360002. Gujarat (India), Call : +91 87994 54774







### Mixtron Dosing Unit (Oil and Water Mixing Device)

- Easily mixing oil and water without manpower.
- Stops wastage of oil
- No electricity required
- Very Helpful product for maintaining coolant concentration.

### Sump Cleaner

- Extended coolant change period
- Reduce storage and Disposal cost of waste coolant
- Extending Tool life and machine life
- Reducing time in coolant disposal from Machine tank



### Cutting Oil

- Improve Tool life and sump life
- Machine cleanliness
- No Human Irritation
- No Bad smell and Rusting issue
- Reduces cutting oil consumption
- Annual Cost Reduction

### Oil Skimmer

- Used for removing un-emulsified oil
- Continued cleaning operation
- Easy in maintenance
- Improve coolant sump life



### Tapping Machine

- Reduce Tap Breakage issue
- Replace Tapping operations from VMC
- Multiple thread in single machine
- Higher Productivity
- Reduce Tool Changing and Programing Time.

### Re-Sharpening Machine

- Easily Regrinding of Drill or Endmill
- Reduce cost of Resharpener (per Endmil or Drill)
- Maximum Grinding on 0.5mm material
- Increases Tool life • Time saving product



### Coolant Nozzles

- Universal Coolant Nozzle for CNC machine
- Hits any target above mounting plane
- Adjust easily for accurate coolant placement
- Choose larger orifices for maximum flow
- Nozzle of 10 bar to 100 bar pressure

WE ARE PROVIDING ALL TYPE OF COOLANT MANAGEMENT SERVICES & SOLUTIONS

**MASCOT™**

CNC Tools & Equipments Pvt. Ltd.

RAJKOT | JAMNAGAR | MORBI | AHMEDABAD

16/28 Vijay Plot, Khodiyar Chowk,  
Bhaktinagar, Rajkot-360002 (Gujarat) INDIA.

+91-9023417035 / +91-7698868689

admin.intl@mascootools.in / rushiraj.jhala@mascootools.in

Power by Intellect driven by values



www.mascootools.in

સરદાર પત્ર

Vardhman Industrial Zone, Plot No-15, S.V. No.-259 B/h-Kothariya Solvet,  
Kothariya, Rajkot - 360002. Gujarat (India), Call : +91 87994 54774

SARDAR  
Engineering & Tools



## Vacuum Heat Treatment

Call Us On : +91 9408097080



Vacuum Heat Treatment Service Provider For D2, H11, H13, M2, M3/2, All ASP Series, SS 410, SS 420, SS 440c, 17-4 Ph, STAWAX



Plot No.18/1, Survey No. 133, Rameshwar Industrial Area-2, Opp. Sangam technocast, B/H Shantidham Soc., At Veraval (Shapar), Dist. Rajkot, Gujarat - 360024

E-mail : [sales@cosmicmetreat.com](mailto:sales@cosmicmetreat.com) | Web : [www.cosmicmetreat.com](http://www.cosmicmetreat.com)



An ISO 9001:2015 Certified Company

Quality is our Motto....

the complete Plumbing solution



MFG : CPVC, UPVC, SWR, AGRICULTURE PIPES & FITTINGS & FRP CHAMBER COVER & COLUMN PIPE

### KAMDHENU POLYPLAST

Add. : Kishan Gate No. 3, Plot No G-2103, Near Fessan Rubber, Metoda GIDC, Rajkot - 360004

Email : [kamdhenupolyplast@gmail.com](mailto:kamdhenupolyplast@gmail.com)

Web : [www.kamdhenupolyplast.com](http://www.kamdhenupolyplast.com)

Mr. Pankajbhai - 93281 32026



MANUFACTURER AND EXPORTER OF HYDRAULIC & OTHER TRACTOR PARTS

Driving Innovation. Powering Agriculture. Your Trusted Source for Quality Tractor Parts!



### KALAPI TRACTOR SPARES PVT.LTD.

Postal Add: Survey No. 206, Pal Ravki Road, Opp. Nayra Petrol Pumps, RAJKOT - 360004, (Gujrat) India.

Contact: Office : +91 99798 98984, 99254 44609  
Email : [info@kalapiauto.com](mailto:info@kalapiauto.com)  
Website : [www.kalapiauto.com](http://www.kalapiauto.com)

સરદાર પત્રા

Vardhman Industrial Zone, Plot No-15, S.V. No.-259 B/h-Kothariya Solvet, Kothariya, Rajkot - 360002. Gujarat (India), Call : +91 87994 54774





An ISO 9001-2015 Certified Company

# Microtight

## FASTNERS LLP

Your Perfect Partner For Fastening Solution

### SOCKET HEAD CAP SCREW (M5 TO M16)

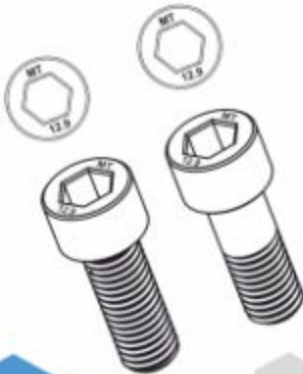

### HEX BOLT (M5 TO M16)

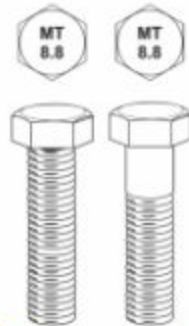

## OUR CAPABILITIES

- ▶ 3600 MT/Year
- ▶ Multi Station Forming Machine (Cold Forge Headers M5 TO M16).
- ▶ Thread Rolling Machines.
- ▶ Mesh Belt heat Treatment Furnace.
- ▶ Fully Automatic Zinc/ Zinc-Nickel Electroplating Plant.
  
- ▶ Well-equipped laboratory-
  - Universal Testing Machine with extensometer for 0.2% proof stress Testing Facility.
  - Rockwell Hardness Testing Machine.
  - Micro Vickers Hardness Testing Machine
  - Salt Spray Testing.
  - XRF (X-ray analysis of coating thickness).
  - Metallurgical Microscope with Image Analyzer.
  - Chemical composition analysis (Spectrometer).
  - Vision Measuring Machine.
  - Non-Distractive testing like MP, DP, UT, RT. With ASNT Level II Qualified technical Staffs

## Microtight Fastners LLP

Survey No.: 331, Plot No.: 1 & 2,  
Nagar Pipaliya Road, DEVLVA,  
Taluka : Lodhika, Dist : Rajkot,  
Gujarat, INDIA - 360021.

☎ : +91-98240 34150

✉ : amit@microtightfastners.com

🌐 : www.microtightfastners.com

☎ : +91-93753 51003

✉ : info@microtightfastners.com



RAJKOT'S FAVOURITE  
**WEDDING DESTINATION**

**PHENIX**  
RESORT

— 3 BANQUETS ~ 3 PARTY LAWNS ~ POOLSIDE VENUE —

**Indoor Capacity** > up to **1200** people | **Outdoor Capacity** > up to **5000** people

Ishwariya Road Corner,  
Kalawad Road, Rajkot.

Contact **+91 74900 45000**